

APPENDIX E
Geotechnical Investigation and Percolation Test Results (March 18, 2021)

**GEOTECHNICAL INVESTIGATION
AND PERCOLATION TEST RESULTS**

**HEACOCK LOGISTICS PARKING
PROJECT
APN 316-211-014, HEACOCK
AVENUE AT PERRIS VALLEY STORM
DRAIN
MORENO VALLEY, CALIFORNIA**



GEOCON
WEST, INC.

GEOTECHNICAL
ENVIRONMENTAL
MATERIALS

PREPARED FOR

LAWRENCE FAMILY TRUST

**MARCH 18, 2021
PROJECT NO. T2925-22-01**



Project No. T2925-22-01
March 18, 2021

Lawrence Family Trust
P O Box 7200
Beverly Hills, CA 90212

Attention: Mr. David Schiepe

Subject: GEOTECHNICAL INVESTIGATION
AND PERCOLATION TEST RESULTS
HEACOCK LOGISTICS PARKING PROJECT
APN 316-211-014, HEACOCK AVENUE AT PERRIS VALLEY STORM DRAIN
MORENO VALLEY, CALIFORNIA

Dear Mr. Schiepe:

In accordance with your authorization of Proposal No. IE-2703, Geocon West Inc. (Geocon) herein submits the results of our geotechnical investigation and percolation test results for the subject site. The accompanying report presents the results of our study and conclusions and recommendations pertaining to the geotechnical aspects of the proposed project. The site is considered suitable for development provided the recommendations of this report are followed.

Should you have questions regarding this report, or if we may be of further service, please contact the undersigned at your convenience.

Very truly yours,

GEOCON WEST, INC.

A handwritten signature in green ink, appearing to read 'L. Weidman'.

Luke C. Weidman
Staff Geologist, GIT 891

A handwritten signature in green ink, appearing to read 'L. Battiato'.

Lisa A. Battiato
CEG 2316



A handwritten signature in green ink, appearing to read 'J. Vettel'.

Joseph J. Vettel
GE 2401



LW:AS:LAB:JJV:hd

Distribution: (1/e-mail) Addressee

TABLE OF CONTENTS

| | |
|--|----|
| 1. PURPOSE AND SCOPE | 1 |
| 2. SITE AND PROJECT DESCRIPTION | 1 |
| 3. SOIL AND GEOLOGIC CONDITIONS | 2 |
| 3.1 Alluvium (Qa)..... | 2 |
| 4. GROUNDWATER | 2 |
| 5. SITE INFILTRATION..... | 3 |
| 6. CONCLUSIONS AND RECOMMENDATIONS..... | 4 |
| 6.1 General..... | 4 |
| 6.2 Excavation and Soil Characteristics | 5 |
| 6.3 Grading | 6 |
| 6.4 Utility Trench Backfill..... | 7 |
| 6.5 Earthwork Grading Factors..... | 7 |
| 6.6 Concrete Flatwork | 8 |
| 6.7 Preliminary Pavement Recommendations..... | 8 |
| 6.8 Site Drainage and Moisture Protection..... | 11 |
| 6.9 Grading Plan Review | 11 |

LIMITATIONS AND UNIFORMITY OF CONDITIONS

LIST OF REFERENCES

MAPS AND ILLUSTRATIONS

Figure 1, Vicinity Map
Figures 2, Geologic Map

APPENDIX A

FIELD INVESTIGATION

Figures A-1 through A-8, Logs of Borings
Figures A-9 and A-12, Percolation Test Reports

APPENDIX B

LABORATORY TESTING

Figure B-1, Compaction Characteristics Using Modified Effort Test Results
Figures B-2, Laboratory Test Results
Figures B-3 and B-4, Grain Size Distribution

APPENDIX C

RECOMMENDED GRADING SPECIFICATIONS

GEOTECHNICAL INVESTIGATION AND PERCOLATION TEST RESULTS

1. PURPOSE AND SCOPE

This report presents the results of our geotechnical investigation and percolation tests for the proposed logistics parking facility to be located on 9.14 acres immediately northeast of the intersection of Heacock Avenue and the Perris Valley Storm Drain in Moreno Valley, California (see *Vicinity Map*, Figure 1). The purposes of the geotechnical investigation and percolation testing are to evaluate the surface and subsurface soil conditions and general site geology, and to identify geotechnical constraints that may affect development of the property. In addition, we provided recommendations for remedial grading, and both flexible and rigid pavement designs. This investigation also included a review of readily available published and unpublished geologic literature (see *List of References*).

The scope of this investigation included performing a site reconnaissance, field exploration, engineering analyses, and preparing this report. We performed our field investigation on February 23, 2021 and February 24, 2021 by excavating seven geotechnical test pits to a maximum depth of 4 feet and one deep geotechnical test pit to a depth of 14 feet below the existing ground surface. Four of the test pits were used to perform percolation testing. The *Geologic Map*, Figure 2, presents the approximate locations of the test pits. *Appendix A* provides a detailed discussion of the field investigation including logs of the borings and percolation test results. Details of the laboratory tests and a summary of the test results are presented in *Appendix B* and on the boring logs in *Appendix A*.

Recommendations presented herein are based on analyses of data obtained from our site investigation and our understanding of proposed site development. References reviewed to prepare this report are provided in the *List of References*. If project details vary significantly from those described herein, Geocon should be contacted to evaluate the necessity for review and possible revision of this report.

2. SITE AND PROJECT DESCRIPTION

The subject site is located immediately northeast of the intersection of Heacock Avenue and the Perris Valley Storm Drain in Moreno Valley, California. The site is bounded on the west by March Air Reserve Base, to the south by the Perris Valley Storm Drain, and to the east and north by undeveloped land. The site is currently vacant with some grass and dead bushes at the surface. The existing grades range from approximate elevation 1,473 feet above Mean Sea Level (MSL) in the southwest corner to 1,484 feet above MSL in the center. The site is at latitude 33.8602 and longitude -117.2425.

Based on the *Exhibit* prepared by CASC Engineering and Consulting, we understand that the proposed at grade parking lot will include up to 255 parking stalls for semi-truck trailers and up to four regular parking stalls. Cuts and fills of approximately 5 feet are planned to achieve proposed finished grades.

The site descriptions and proposed development are based on a site reconnaissance, review of published geologic literature, our field investigation, a review of the preliminary exhibit, and discussions with you. If development plans differ from those described herein, Geocon should be contacted for review of the plans and possible revisions to this report.

3. SOIL AND GEOLOGIC CONDITIONS

The only geologic material observed across the site, and to the depths explored, during our field investigation is Holocene-aged alluvium. This is shown on the *Geologic Map*, Figure 2, and in the boring logs in *Appendix A*.

3.1 Alluvium (Qa)

Alluvium was observed within all of the test pits during our geotechnical investigation to depths of 4 to 14 feet. This unit consists of silty sand, sandy silt, and well-graded sand. The top 1 to 2 feet of alluvium was observed to be a loose and dry. Below this, the alluvium becomes medium dense and damp. The silty sand is characterized as dark brown with predominantly fine to medium sand and some coarse sand. At approximately 3 feet the unit shifts to a sandy silt that can be characterized as medium dense, damp, and strong brown. At approximately 10 feet there is a gradational shift in sediment to a well-graded sand that extends to the maximum depth explored (14 feet, TP-1). The well-graded sand is characterized as medium dense, moist, and very dark brown to dark reddish brown. Weathering rinds on some of the coarse sand grains were also observed.

4. GROUNDWATER

We did not encounter groundwater or seepage during the site investigation. According to the California Department of Water Resources, wells in the area indicate a historical depth to groundwater of between 10 and 90 feet below the existing ground surface. It is not uncommon for seepage conditions to develop where none previously existed. Groundwater and seepage are dependent on seasonal precipitation, irrigation, land use, among other factors, and varies as a result. Proper surface drainage will be important to future performance of the project.

5. SITE INFILTRATION

Percolation testing was performed in accordance with the procedures in *Riverside County Flood Control and Water Conservation District LID BMP, Appendix A*. The percolation test locations are depicted on the *Geologic Map* (see Figure 2).

A 3-inch diameter perforated PVC pipe in silt filter sock was placed in each percolation test hole and approximately 2 inches of gravel was placed at the bottom of the PVC pipe. The test locations were pre-saturated prior to testing. Percolation testing was begun within 24 hours after the holes were presaturated. Percolation data sheets are presented in *Appendix A* of this report. Calculations to convert the percolation test rate to infiltration test rates are presented in Table 5.0 below. Note that the Handbook requires a factor of safety of 3 be applied to the values below based on the test method used.

**TABLE 5.0
INFILTRATION TEST RATES FOR PERCOLATION AREAS**

| Parameter | P-1 | P-2 | P-3 | P-4 |
|---|--------|--------|--------|--------|
| Depth (inches) | 48 | 48 | 48 | 48 |
| Test Type | Normal | Normal | Normal | Normal |
| Change in head over time: ΔH (inches) | 1.4 | 1.4 | 3.0 | 2.4 |
| Average head: H_{avg} (inches) | 9.5 | 10.8 | 9.3 | 8.8 |
| Time Interval (minutes): Δt (minutes) | 30 | 30 | 30 | 30 |
| Radius of test hole: r (inches) | 4 | 4 | 4 | 4 |
| Tested Infiltration Rate: I_t (inches/hour) | 0.5 | 0.5 | 1.1 | 0.9 |

The in-situ field percolation tests performed provide short-term infiltration rates, which apply mainly to the initiation of the infiltration process due to the short time of the test (hours instead of days) and the amount of water used. Where appropriate the short-term infiltration rates shall be converted to long-term infiltration rates using reduction factors depending upon the degree of infiltrate quality, maintenance access and frequency, site variability, subsurface stratigraphy variation, and other factors. The small-scale percolation testing cannot model the complexity of the effect of interbedded layers of different soil composition, and our test results should be considered only as index values of infiltration rates.

6. CONCLUSIONS AND RECOMMENDATIONS

6.1 General

- 6.1.1 From a geotechnical engineering standpoint, the site is suitable for construction of the proposed on-grade parking lot provided the recommendations presented herein are implemented in design and construction of the project.
- 6.1.2 Our field investigation indicates the site is underlain by alluvium. The upper portion of the alluvium is not considered suitable for development. Remedial grading of the surficial soil will be required as discussed herein. The existing site soils are suitable for re-use as engineered fill provided the recommendations in the *Grading* section of this report are followed.
- 6.1.3 Moisture contents in the borings varied significantly between the upper and lower alluvium. Moisture conditioning of the soils should be expected during construction. Special handling of the soil should be anticipated, particularly if grading occurs during the rainy season.
- 6.1.4 Although the majority of on-site soils consist of silty sands, some granular material, having little to no cohesion and subject to caving in unshored excavations, should be expected at the site. It is the responsibility of the contractor to ensure that excavations and trenches are properly shored and maintained in accordance with OSHA rules and regulations to maintain the stability of adjacent existing improvements.
- 6.1.5 The developer should consider the use of a dry well or similar rock well in the infiltration areas so that a conduit is created to the more permeable well graded sand layer encountered in the deep excavation in TP-1.
- 6.1.6 Based on the exhibit, cuts and fills ranging up to 5 feet are planned to achieve finish grades.
- 6.1.7 We did not encounter groundwater during our investigation and do not expect groundwater would impact site improvements. However, wet conditions and seepage could affect proposed construction if grading and improvement operations occur during or shortly after a rain event.
- 6.1.8 Proper drainage should be maintained in order to preserve the design properties of the fill in the sheet-graded pad and slope areas.
- 6.1.9 Changes in the design, location, or elevation of improvements, as outlined in this report, should be reviewed by this office.
- 6.1.10 Recommended grading specifications are provided in *Appendix C*.

6.2 Excavation and Soil Characteristics

6.2.1 Excavation of the alluvium should be possible with moderate to heavy effort using conventional heavy-duty equipment.

6.2.2 We performed laboratory tests on samples of the site materials to evaluate the percentage of water-soluble sulfate content. *Appendix B* presents results of the laboratory water-soluble sulfate content tests. The test results indicate the on-site materials at the location tested possess a sulfate content of 0.000 percent (0 parts per million [ppm]) equating to an exposure class of “S0” as defined by 2019 CBC Section 1904.3 and ACI 318. Table 6.2.2 presents a summary of concrete requirements set forth by 2019 CBC Section 1904.3 and ACI 318. The presence of water-soluble sulfates is not a visually discernible characteristic; therefore, other soil samples from the site could yield different concentrations. Additionally, over time landscaping activities (i.e., addition of fertilizers and other soil nutrients) may affect the concentration.

**TABLE 6.2.2
REQUIREMENTS FOR CONCRETE EXPOSED TO
SULFATE-CONTAINING SOLUTIONS**

| Exposure Class | Water-Soluble Sulfate (SO ₄) Percent by Weight | Cement Type (ASTM C 150) | Maximum Water to Cement Ratio by Weight ¹ | Minimum Compressive Strength (psi) |
|----------------|--|--------------------------|--|------------------------------------|
| S0 | SO ₄ <0.10 | No Type Restriction | n/a | 2,500 |
| S1 | 0.10 ≤ SO ₄ < 0.20 | II | 0.50 | 4,000 |
| S2 | 0.20 ≤ SO ₄ ≤ 2.00 | V | 0.45 | 4,500 |
| S3 | SO ₄ > 2.00 | V+Pozzolan or Slag | 0.45 | 4,500 |

¹ Maximum water to cement ratio limits do not apply to lightweight concrete.

6.2.3 Geocon does not practice in the field of corrosion engineering. Therefore, further evaluation by a corrosion engineer may be performed if improvements that could be susceptible to corrosion are planned.

6.3 Grading

- 6.3.1 Grading should be performed in accordance with the recommendations provided in this report, the *Recommended Grading Specifications* contained in *Appendix C* and the City of Moreno Valley's Standards.
- 6.3.2 Prior to commencing grading, a pre-construction conference should be held at the site with the owner/developer, city inspector, grading contractor, civil engineer, and geotechnical engineer in attendance. Special soil handling requirements can be discussed at that time.
- 6.3.3 Site preparation should begin with the removal of deleterious material, debris, buried trash, and vegetation. The depth of removal should be such that material exposed in cut areas or soil to be used as fill is relatively free of organic matter. Material generated during stripping and/or site demolition should be exported from the site.
- 6.3.4 The upper portion of the alluvium should be removed to expose competent material. Based on our findings, we expect the existing soils within approximately 3 feet below subgrade elevation will require remedial excavation and proper compaction. Areas of loose, dry, or compressible soils will require additional excavation and processing prior to fill placement. The excavations should be extended laterally a minimum distance of 3 feet beyond the parking lot footprint or for a distance equal to the depth of removal, whichever is greater.
- 6.3.5 The actual depth of removal should be evaluated by the engineering geologist during grading operations. Deeper excavations may be required if dry, loose, soft, or porous materials are present at the base of the removals. The bottom of the excavations should be scarified to a depth of at least 1 foot, moisture conditioned as necessary, and properly compacted.
- 6.3.6 The site should then be brought to final subgrade elevations with fill compacted in layers. In general, soil native to the site is suitable for use as fill if free from vegetation, debris, and other deleterious material. Layers of fill should be about 6 to 8 inches in loose thickness and no thicker than will allow for adequate bonding and compaction. Fill, including backfill and scarified ground surfaces, should be compacted to a dry density of at least 90 percent of the laboratory maximum dry density at 0 to 2 percent above optimum moisture content, as determined in accordance with ASTM D 1557. Fill materials placed below optimum moisture content may require additional moisture conditioning prior to placing additional fill. The upper 12 inches of subgrade soil underlying pavement should be compacted to a dry density of at least 95 percent of the laboratory maximum dry density at 0 to 2 percent above optimum moisture content shortly before paving operations.

6.4 Utility Trench Backfill

- 6.4.1 Utility trenches should be properly backfilled in accordance with the requirements of the City of Moreno Valley and the latest edition of the *Standard Specifications for Public Works Construction* (Greenbook). The pipes should be bedded with well-graded crushed rock or clean sand (Sand Equivalent greater than 30) to a depth of at least one foot over the pipe. If open graded rock is used, it should be wrapped in filter fabric to prevent finer soils from migrating into the rock voids. The remainder of the trench backfill may be derived from onsite soil. Backfill of utility trenches should not contain rocks greater than 3 inches in diameter. The use of 2-sack slurry and controlled low strength material (CLSM) are also acceptable as backfill; however, consideration should be given to the possibility of differential settlement where the slurry ends and earthen backfill begins. These transitions should be minimized, and additional stabilization should be considered at these transitions.
- 6.4.2 Utility trench backfill should be placed in layers no thicker than will allow for adequate bonding and compaction. Utility backfill should be compacted to a dry density of at least 90 percent of the laboratory maximum dry density and moisture conditioned at or slightly above optimum moisture content (as determined by ASTM D1557). Backfill within the upper 12 inches of finish subgrade elevation of new pavements should be compacted to at least 95 percent of the maximum dry density. Backfill materials placed below the recommended moisture content may require additional moisture conditioning prior to placing additional fill.

6.5 Earthwork Grading Factors

- 6.5.1 Estimates of shrinkage factors are based on empirical judgments comparing the material in its existing or natural state as encountered in the exploratory excavations to a compacted state. Variations in natural soil density and in compacted fill density render shrinkage value estimates very approximate. As an example, the contractor can compact the fill to a dry density of 90 percent or higher of the laboratory maximum dry density. Thus, the contractor has an approximately 10 percent range of control over the fill volume. Based on our experience and the densities measured during our investigation, the shrinkage of the upper portion of the alluvium is expected to be on the order of 5 to 10 percent when compacted to at least 90 percent of the laboratory maximum dry density. This estimate is for preliminary quantity estimates only. Due to the variations in the actual shrinkage/bulking factors, a balance area should be provided to accommodate variations.

6.6 Concrete Flatwork

- 6.6.1 Exterior concrete flatwork not subject to vehicular traffic should be constructed in accordance with the recommendations herein. Slab panels should be a minimum of 4 inches thick and, when in excess of 8 feet square, should be reinforced with No. 3 reinforcing bars spaced 24 inches on center in each direction to reduce the potential for wide cracking. In addition, concrete flatwork should be provided with crack control joints to reduce and/or control shrinkage cracking. Crack control spacing should be determined by the project structural engineer based upon the slab thickness and intended usage. Criteria of the American Concrete Institute (ACI) should be taken into consideration when establishing crack control spacing. Subgrade soil for exterior slabs not subjected to vehicle loads should be compacted in accordance with criteria presented in the grading section prior to concrete placement. Subgrade soil should be properly compacted and the moisture content of subgrade soil should be checked prior to placing concrete.
- 6.6.2 Even with the incorporation of the recommendations within this report, the exterior concrete flatwork has a likelihood of experiencing some movement due to swelling or settlement; therefore, the steel reinforcement should overlap continuously in flatwork to reduce the potential for vertical offsets within flatwork. Additionally, flatwork should be structurally connected to the curbs, where possible, to reduce the potential for offsets between the curbs and the flatwork.
- 6.6.3 The recommendations presented herein are intended to reduce the potential for cracking as a result of differential movement. However, even with the incorporation of the recommendations presented herein, concrete will still crack. The occurrence of concrete shrinkage cracks is independent of the soil supporting characteristics. Their occurrence may be reduced and/or controlled by limiting the slump of the concrete, the use of crack control joints and proper concrete placement and curing. Crack control joints should be spaced at intervals no greater than 12 feet. Literature provided by the Portland Concrete Association (PCA) and American Concrete Institute (ACI) present recommendations for proper concrete mix, construction, and curing practices, and should be incorporated into project construction.

6.7 Preliminary Pavement Recommendations

- 6.7.1 We calculated the flexible pavement sections in general conformance with the *Caltrans Method of Flexible Pavement Design* (Highway Design Manual, Section 608.4) and evaluated the pavement thickness based on the City of Moreno Valley specifications using a range of Traffic Indices (TI). Based on laboratory testing of onsite soils, we used a preliminary R-value of 35 for the subgrade soils for the purpose of this analysis. Laboratory R-value testing results are presented in *Appendix B*. The final pavement sections should be

based on the R-value of the subgrade soil encountered at final subgrade elevation. Table 6.7.1 presents a recommended preliminary flexible pavement section for a TI of 10; this TI was selected per Moreno Valley Standard MVSI-100A-1. The project Civil Engineer should evaluate the final Traffic Index for proposed pavements that is applicable to the project.

**TABLE 6.7.1
PRELIMINARY FLEXIBLE PAVEMENT SECTION**

| Location | Assumed Traffic Index | Subgrade R-Value | Asphalt Concrete (inches) | Class 2 Aggregate Base (inches) |
|-------------------------------------|-----------------------|------------------|---------------------------|---------------------------------|
| Truck Drive Aisle and Parking Areas | 10 | 35 | 6½ | 13 |

6.7.2 Prior to placing base materials, the upper 12 inches of the subgrade soil should be scarified, moisture conditioned as necessary, and recompact to a dry density of at least 95 percent of the laboratory maximum dry density at 0 to 2 percent above optimum moisture content as determined by ASTM D1557.

6.7.3 Asphalt concrete should conform to Section 203-6 of the Greenbook. Class 2 aggregate base materials should conform to Section 26-1.02A of the “*Standard Specifications of the State of California, Department of Transportation*” (Caltrans). Base materials should be compacted to a dry density of at least 95 percent of the laboratory maximum dry density, at or slightly above optimum moisture content. Asphalt concrete should be compacted to a density of 95 percent of the laboratory Hveem density in accordance with ASTM D1561. The asphalt concrete should conform to Section 203-6 of the *Standard Specifications for Public Works Construction (Greenbook)*.

6.7.4 A rigid Portland cement concrete (PCC) pavement section should be placed in heavy truck areas, driveway aprons, and cross gutters. We calculated the rigid pavement section in general conformance with the procedure recommended by the American Concrete Institute report ACI 330R *Guide for Design and Construction of Concrete Parking Lots* using the parameters presented in Table 6.7.4.

**TABLE 6.7.4
RIGID PAVEMENT DESIGN PARAMETERS**

| Design Parameter | Design Value |
|---|--------------|
| Modulus of subgrade reaction, k | 100 pci |
| Modulus of rupture for concrete, M _R | 500 psi |
| Traffic Category, TC | C and D |
| Average daily truck traffic, ADTT | 300 and 700 |

6.7.5 Based on the criteria presented herein, the PCC pavement sections should have a minimum thickness as presented in Table 6.7.5.

**TABLE 6.7.5
RIGID PAVEMENT RECOMMENDATIONS**

| Location | Portland Cement Concrete (inches) |
|--|-----------------------------------|
| Automobile Parking Stalls (TC=C) | 7½ |
| Heavy Truck and Fire Lane Areas (TC=D) | 8 |

6.7.6 The PCC pavement should be placed over subgrade soil that is compacted to a dry density of at least 95 percent of the laboratory maximum dry density at 0 to 2 percent above optimum moisture content. This pavement section is based on a minimum concrete compressive strength of approximately 3,500 psi (pounds per square inch).

6.7.7 A thickened edge or integral curb should be constructed on the outside of concrete slabs subjected to wheel loads. The thickened edge should be 1.2 times the slab thickness or a minimum thickness of 2 inches, whichever results in a thicker edge, and taper back to the recommended slab thickness 4 feet behind the face of the slab (e.g., 6-inch and 7.5-inch-thick slabs would have an 8- and 9.5-inch-thick edge, respectively). Reinforcing steel will not be necessary within the concrete for geotechnical purposes with the possible exception of dowels at construction joints as discussed herein.

6.7.8 In order to control the location and spread of concrete shrinkage cracks, crack-control joints (weakened plane joints) should be included in the design of the concrete pavement slab in accordance with the referenced ACI report.

6.7.9 The performance of pavements is highly dependent on providing positive surface drainage away from the edge of the pavement. Ponding of water on or adjacent to the pavement surfaces will likely result in pavement distress and subgrade failure. Drainage from landscaped areas should be directed to controlled drainage structures. Landscape areas adjacent to the edge of asphalt pavements are not recommended due to the potential for surface or irrigation water to infiltrate the underlying permeable aggregate base and cause distress. Where such a condition cannot be avoided, consideration should be given to incorporating measures that will significantly reduce the potential for subsurface water migration into the aggregate base. If planter islands are planned, the perimeter curb should extend at least 6 inches below the level of the base materials.

6.8 Site Drainage and Moisture Protection

- 6.8.1 Adequate site drainage is critical to reduce the potential for differential soil movement, erosion, and subsurface seepage. Under no circumstances should water be allowed to pond. The site should be graded and maintained such that surface drainage is directed away from the site in accordance with 2019 CBC 1804.4 or other applicable standards. In addition, surface drainage should be directed away from the top of slopes into swales or other controlled drainage devices. Roof and pavement drainage should be directed into conduits that carry runoff away from the proposed parking lot.
- 6.8.2 Underground utilities should be leak free. Utility and irrigation lines should be checked periodically for leaks, and detected leaks should be repaired promptly. Detrimental soil movement could occur if water is allowed to infiltrate the soil for prolonged periods of time.
- 6.8.3 Landscaping planters adjacent to paved areas are not recommended due to the potential for surface or irrigation water to infiltrate the pavement's subgrade and base course. Area drains to collect excess irrigation water and transmit it to drainage structures or impervious above-grade planter boxes can be used. In addition, where landscaping is planned adjacent to the pavement, construction of a cutoff wall along the edge of the pavement that extends at least 6 inches below the bottom of the base material should be considered.
- 6.8.4 If not properly constructed, there is a potential for distress to improvements and properties located hydrologically down gradient or adjacent to infiltration areas. Factors such as the amount of water to be detained, its residence time, and soil permeability have an important effect on seepage transmission and the potential adverse impacts that may occur if the storm water management features are not properly designed and constructed. We have not performed a hydrogeology study at the site. Down-gradient and adjacent structures may be subjected to seeps, movement of foundations and slabs, or other impacts as a result of water infiltration.

6.9 Grading Plan Review

- 6.9.1 Geocon should review the project grading plans prior to final design submittal to verify that the plans have been prepared in substantial conformance with the recommendations of this report and to provide additional analyses or recommendations, if necessary.

LIMITATIONS AND UNIFORMITY OF CONDITIONS

1. The firm that performed the geotechnical investigation for the project should be retained to provide testing and observation services during construction to provide continuity of geotechnical interpretation and to check that the recommendations presented for geotechnical aspects of site development are incorporated during site grading, construction of improvements, and excavation of foundations. If another geotechnical firm is selected to perform the testing and observation services during construction operations, that firm should prepare a letter indicating their intent to assume the responsibilities of project geotechnical engineer of record. A copy of the letter should be provided to the regulatory agency for their records. In addition, that firm should provide revised recommendations concerning the geotechnical aspects of the proposed development, or a written acknowledgement of their concurrence with the recommendations presented in our report. They should also perform additional analyses deemed necessary to assume the role of Geotechnical Engineer of Record.
2. The recommendations of this report pertain only to the site investigated and are based upon the assumption that the soil conditions do not deviate from those disclosed in the investigation. If any variations or undesirable conditions are encountered during construction, or if the proposed construction will differ from that anticipated herein, Geocon should be notified so that supplemental recommendations can be given. The evaluation or identification of the potential presence of hazardous or corrosive materials was not part of the scope of services provided by Geocon.
3. This report is issued with the understanding that it is the responsibility of the owner or their representative to ensure that the information and recommendations contained herein are brought to the attention of the architect and engineer for the project and incorporated into the plans, and the necessary steps are taken to see that the contractor and subcontractors carry out such recommendations in the field.
4. The findings of this report are valid as of the date of this report. However, changes in the conditions of a property can occur with the passage of time, whether they be due to natural processes or the works of man on this or adjacent properties. In addition, changes in applicable or appropriate standards may occur, whether they result from legislation or the broadening of knowledge. Accordingly, the findings of this report may be invalidated wholly or partially by changes outside our control. Therefore, this report is subject to review and should not be relied upon after a period of three years.

LIST OF REFERENCES

1. American Concrete Institute, 2014, *Building Code Requirements for Structural Concrete and Commentary on Building Code Requirements for Structural Concrete*, prepared by the American Concrete Institute Committee 318, dated September.
2. American Concrete Institute, 2008, *330R Guide for the Design and Construction of Concrete Parking Lots*, American Concrete Institute Committee 330, dated June.
3. American Concrete Institute, 2006, *302.2R Guide for Guide for Concrete Slabs that Receive Moisture-Sensitive Flooring Materials*, American Concrete Institute Committee 302.
4. California Building Standards Commission, 2019, *California Building Code (CBC)*, California Code of Regulations Title 24, Part 2.
5. California Department of Transportation (Caltrans), 2018, Division of Engineering Services, Materials Engineering and Testing Services, *Corrosion Guidelines, Version 3.0*, dated March.
6. Caltrans, 2018, Standard Specifications.
7. CASC Engineering and Consulting, *Exhibit*, undated
8. City of Moreno Valley, *Standard Plans*, updated November 2019.
9. Public Works Standards, Inc., 2018, *Standard Specifications for Public Works Construction "Greenbook"*, Published by BNi Building News.
10. Riverside County Flood Control and Water Conservation District, 2011, *Design Handbook for Low Impact Development Best Management Practices*, dated month of September.

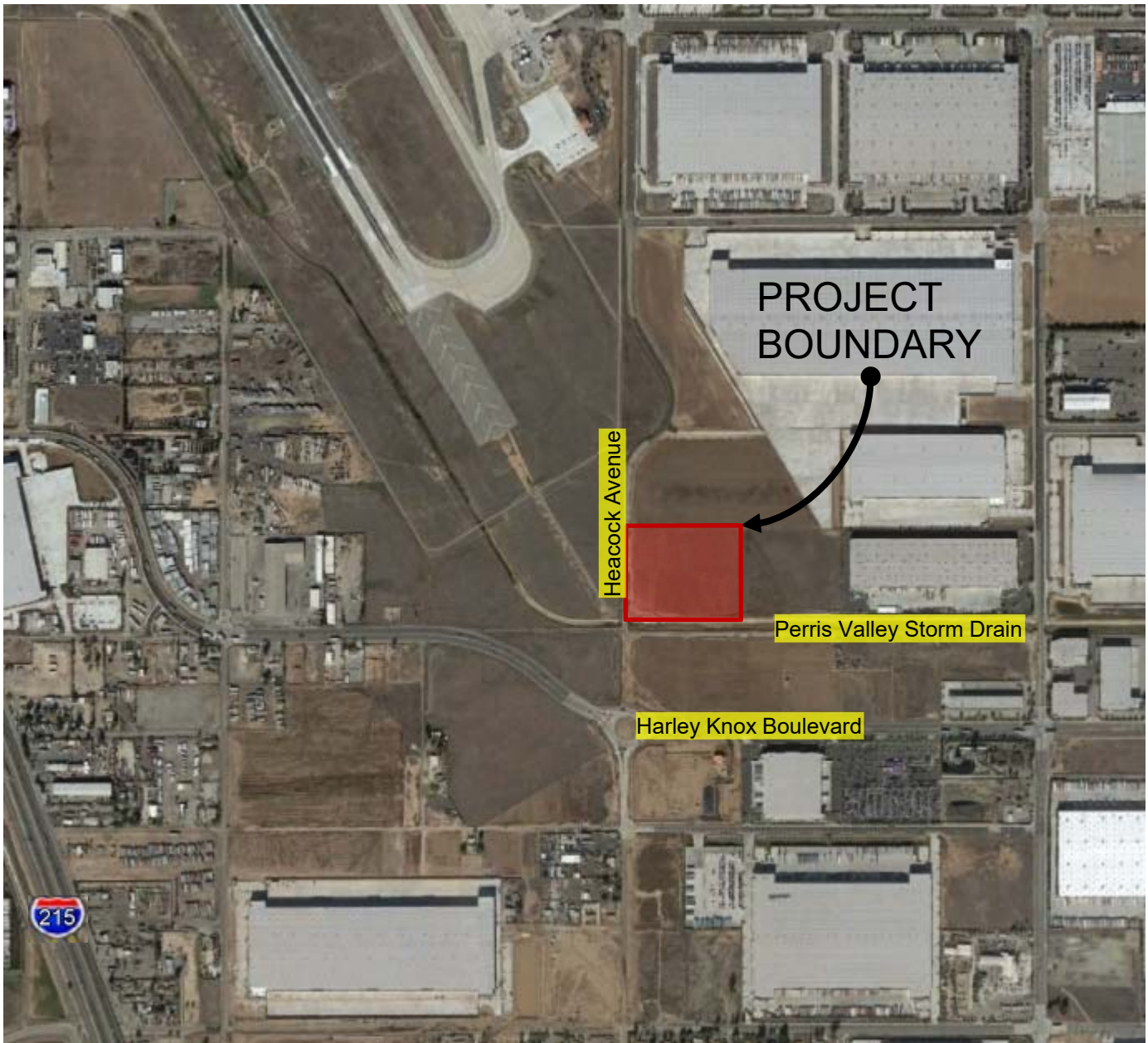

SOURCE: Google Earth, 2021

VICINITY MAP

GEOCON
WEST, INC.



GEOTECHNICAL, ENVIRONMENTAL, MATERIALS
41571 CORNING PLACE #101, MURRIETA, CALIFORNIA 92562
PHONE 951-304-2300 FAX 951-304-2392

HEACOCK LOGISTICS PARKING PROJECT
APN 316-211-014, HEACOCK AVENUE
AT PERRIS VALLEY STORM DRAIN
MORENO VALLEY, CALIFORNIA

LCW

MARCH 2021 PROJECT NO. T2925-22-01 FIG. 1

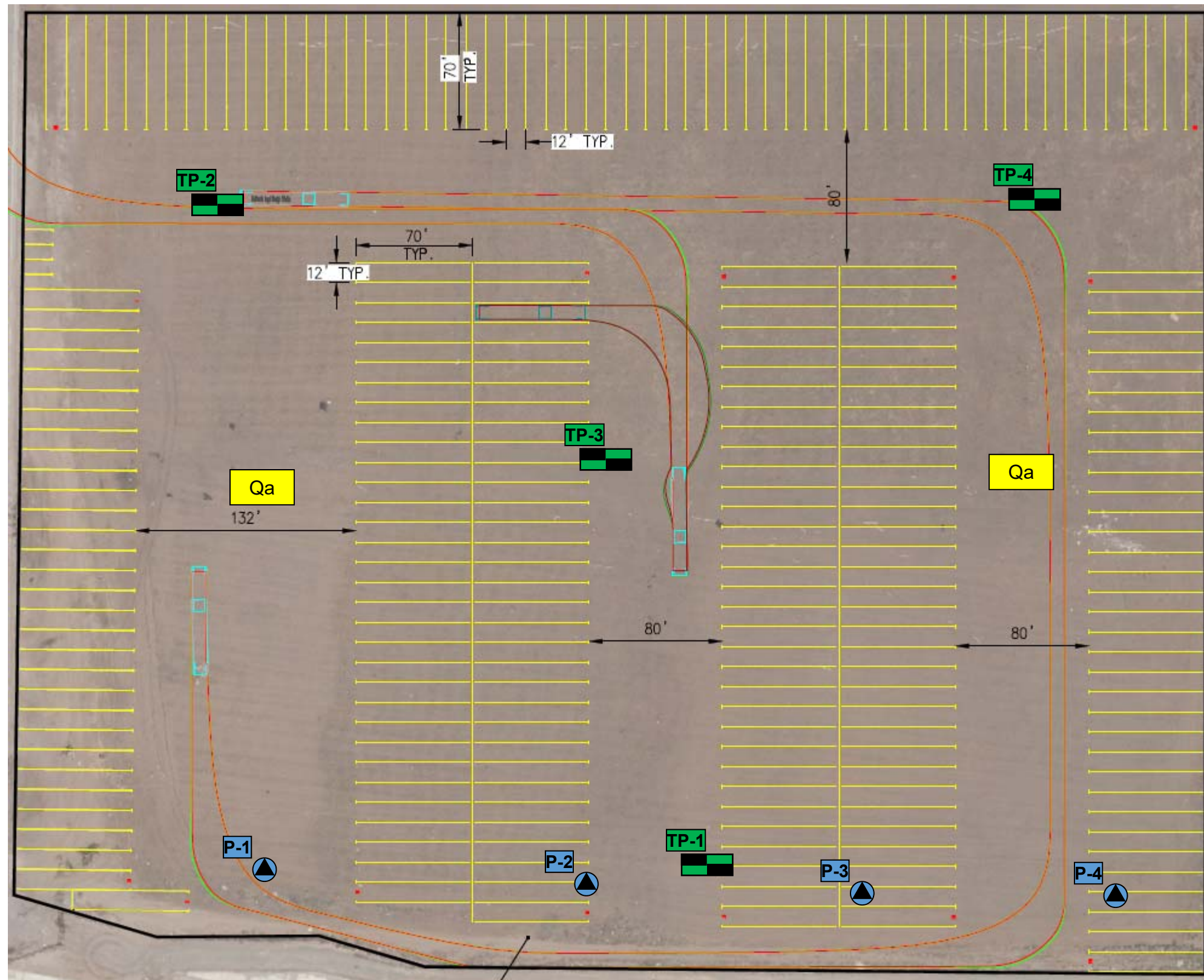

GEOCON LEGEND

Locations are approximate

- TP-4** GEOTECHNICAL TEST PIT LOCATION
- P-4** PERCOLATION TEST LOCATION
- Qa** ALLUVIUM

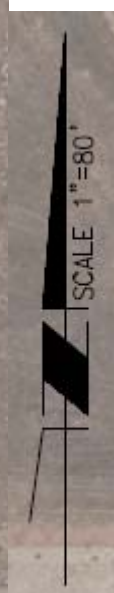

Source: CASC Engineering and Consulting, *Exhibit*, dated October 5, 2020

GEOCON
 WEST, INC.
 GEOTECHNICAL, ENVIRONMENTAL, MATERIALS
 41571 CORNING PLACE #101, MURRIETA, CALIFORNIA 92562
 PHONE 951-304-2300 FAX 951-304-2392



GEOLOGIC MAP

HEACOCK LOGISTICS PARKING PROJECT
 APN 316-211-014, HEACOCK AVENUE
 AT PERRIS VALLEY STORM DRAIN
 MORENO VALLEY, CALIFORNIA

LCW

MARCH 2021

PROJECT NO. T2925-22-01

FIG. 2

APPENDIX



APPENDIX A

FIELD INVESTIGATION

The investigation was performed on February 23, 2021, and February 24, 2021. It consisted of a site reconnaissance and excavation of eight exploratory test pits utilizing a rubber-tire backhoe equipped with a 24-inch bucket. Field work included soil sampling, in place density moisture testing at depths of -1 and -3 feet, and percolation testing. The *Geologic Map*, Figure 2 presents the locations of the exploratory test pits. Test pit logs and an explanation of the geologic units encountered are presented in figures following the text in this appendix.

We collected bulk samples from the test pits and transported them to our laboratory for testing. The type of sample is noted on the exploratory test pit logs.

We visually examined the soil conditions encountered within the test pits, classified, and logged in general accordance with the Unified Soil Classification System (USCS). Logs of the test pits are presented on Figures A-1 through A-8. The logs depict the general soil and geologic conditions encountered and the depth at which we obtained the samples. The *Geologic Map*, Figure 2 presents the locations of the exploratory test pits.

Percolation testing was performed on February 24, 2021 in accordance with *Riverside County Flood Control and Water Conservation District, LID BMP Manual, Appendix A*. The percolation tests were run in accordance with *Section 2.3., Shallow Percolation Test*. The percolation test data is presented on Figures A-9 and A-12.

| DEPTH IN FEET | SAMPLE NO. | LITHOLOGY | GROUNDWATER | SOIL CLASS (USCS) | TEST PIT P-1 | | PENETRATION RESISTANCE (BLOWS/FT.) | DRY DENSITY (P.C.F.) | MOISTURE CONTENT (%) |
|---------------|------------|-----------|-------------|-------------------|---|----------------------------------|------------------------------------|----------------------|----------------------|
| | | | | | ELEV. (MSL.) <u>1474</u> | DATE COMPLETED <u>02/23/2021</u> | | | |
| | | | | | EQUIPMENT <u>BACKHOE</u> BY: <u>Weidman</u> | | | | |
| | | | | | MATERIAL DESCRIPTION | | | | |
| 0 | P-1@0-3 | | | SM | ALLUVIUM (Qa) Silty SAND, loose, dry, dark brown; fine to medium sand; rootlets; grass at surface - Becomes medium dense, damp; some coarse sand | | | 110.1 | 7.6 |
| 2 | | | | ML | | | | | |
| 4 | P-1@4' | | | | Total Depth = 4' Groundwater not encountered Backfilled with cuttings 2/23/2021 | | | | |

Figure A-1,
Log of Test Pit P-1, Page 1 of 1

BORING LOGS.GPJ

| | | | |
|----------------|-----------------------------|-------------------------------|--------------------------------|
| SAMPLE SYMBOLS | ... SAMPLING UNSUCCESSFUL | ... STANDARD PENETRATION TEST | ... DRIVE SAMPLE (UNDISTURBED) |
| | ... DISTURBED OR BAG SAMPLE | ... CHUNK SAMPLE | ... WATER TABLE OR SEEPAGE |

NOTE: THE LOG OF SUBSURFACE CONDITIONS SHOWN HEREON APPLIES ONLY AT THE SPECIFIC BORING OR TRENCH LOCATION AND AT THE DATE INDICATED. IT IS NOT WARRANTED TO BE REPRESENTATIVE OF SUBSURFACE CONDITIONS AT OTHER LOCATIONS AND TIMES.

| DEPTH IN FEET | SAMPLE NO. | LITHOLOGY | GROUNDWATER | SOIL CLASS (USCS) | TEST PIT P-2 | | PENETRATION RESISTANCE (BLOWS/FT.) | DRY DENSITY (P.C.F.) | MOISTURE CONTENT (%) | |
|---------------------|---------------|-----------|-------------|-------------------------|---|----------------------------------|--|-------------------------|-------------------------|---|
| | | | | | ELEV. (MSL.) <u>1473</u> | DATE COMPLETED <u>02/23/2021</u> | | | | |
| | | | | | EQUIPMENT <u>BACKHOE</u> BY: <u>Weidman</u> | | | | | |
| | | | | | MATERIAL DESCRIPTION | | | | | |
| 0 | P-2@0-3 | | | SM | ALLUVIUM (Qa) Silty SAND, loose, dry, dark brown; fine to medium sand; rootlets; grass at surface - Becomes medium dense, damp; some coarse sand | | | 107.7 | 8.6 | |
| 2 | | | | ML | | | | | | Sandy SILT, medium dense, damp, strong brown; fine to medium sand |
| 4 | P-2@4' | | | | Total Depth = 4' Groundwater not encountered Backfilled with cuttings 2/23/2021 | | | | | |

Figure A-2,
Log of Test Pit P-2, Page 1 of 1

BORING LOGS.GPJ

| | | | | | | |
|----------------|--|-----------------------------|--|-------------------------------|--|--------------------------------|
| SAMPLE SYMBOLS | | ... SAMPLING UNSUCCESSFUL | | ... STANDARD PENETRATION TEST | | ... DRIVE SAMPLE (UNDISTURBED) |
| | | ... DISTURBED OR BAG SAMPLE | | ... CHUNK SAMPLE | | ... WATER TABLE OR SEEPAGE |

NOTE: THE LOG OF SUBSURFACE CONDITIONS SHOWN HEREON APPLIES ONLY AT THE SPECIFIC BORING OR TRENCH LOCATION AND AT THE DATE INDICATED. IT IS NOT WARRANTED TO BE REPRESENTATIVE OF SUBSURFACE CONDITIONS AT OTHER LOCATIONS AND TIMES.

| DEPTH IN FEET | SAMPLE NO. | LITHOLOGY | GROUNDWATER | SOIL CLASS (USCS) | TEST PIT P-3 | | PENETRATION RESISTANCE (BLOWS/FT.) | DRY DENSITY (P.C.F.) | MOISTURE CONTENT (%) | |
|---------------------|---------------|-----------|-------------|-------------------------|---|----------------------------------|--|-------------------------|-------------------------|---|
| | | | | | ELEV. (MSL.) <u>1473</u> | DATE COMPLETED <u>02/23/2021</u> | | | | |
| | | | | | EQUIPMENT <u>BACKHOE</u> BY: <u>Weidman</u> | | | | | |
| | | | | | MATERIAL DESCRIPTION | | | | | |
| 0 | P-3@0-3 | | | SM | ALLUVIUM (Qa) Silty SAND, loose, dry, dark brown; fine to medium sand; rootlets; grass at surface - Becomes medium dense, damp; some coarse sand | | | 107.2 | 8.1 | |
| 2 | | | | ML | | | | | | Sandy SILT, medium dense, damp, strong brown; fine to medium sand |
| 4 | P-3@4' | | | | Total Depth = 4' Groundwater not encountered Backfilled with cuttings 2/23/2021 | | | | | |

Figure A-3,
Log of Test Pit P-3, Page 1 of 1

BORING LOGS.GPJ

| | | | | | | |
|----------------|--|-----------------------------|--|-------------------------------|--|--------------------------------|
| SAMPLE SYMBOLS | | ... SAMPLING UNSUCCESSFUL | | ... STANDARD PENETRATION TEST | | ... DRIVE SAMPLE (UNDISTURBED) |
| | | ... DISTURBED OR BAG SAMPLE | | ... CHUNK SAMPLE | | ... WATER TABLE OR SEEPAGE |

NOTE: THE LOG OF SUBSURFACE CONDITIONS SHOWN HEREON APPLIES ONLY AT THE SPECIFIC BORING OR TRENCH LOCATION AND AT THE DATE INDICATED. IT IS NOT WARRANTED TO BE REPRESENTATIVE OF SUBSURFACE CONDITIONS AT OTHER LOCATIONS AND TIMES.

| DEPTH IN FEET | SAMPLE NO. | LITHOLOGY | GROUNDWATER | SOIL CLASS (USCS) | TEST PIT P-4 | | PENETRATION RESISTANCE (BLOWS/FT.) | DRY DENSITY (P.C.F.) | MOISTURE CONTENT (%) | |
|---------------------|---------------|-----------|-------------|-------------------------|---|----------------------------------|--|-------------------------|-------------------------|--|
| | | | | | ELEV. (MSL.) <u>1473</u> | DATE COMPLETED <u>02/23/2021</u> | | | | |
| | | | | | EQUIPMENT <u>BACKHOE</u> BY: <u>Weidman</u> | | | | | |
| | | | | | MATERIAL DESCRIPTION | | | | | |
| 0 | P-4@0-3 | | | SM | ALLUVIUM (Qa) Silty SAND, loose, dry, dark brown; fine to medium sand; rootlets; grass at surface - Becomes medium dense, damp; some coarse sand | | | 109.2 | 6.1 | |
| 2 | | | | ML | Sandy SILT, medium dense, damp, strong brown; fine to medium sand | | | 114.9 | 13.6 | |
| 4 | P-4@4' | | | | Total Depth = 4' Groundwater not encountered Backfilled with cuttings 2/23/2021 | | | | | |

Figure A-4,
Log of Test Pit P-4, Page 1 of 1

BORING LOGS.GPJ

| SAMPLE SYMBOLS | | |
|----------------|-----------------------------|--|
| | ... SAMPLING UNSUCCESSFUL | |
| | ... DISTURBED OR BAG SAMPLE | |
| | | |
| | | |
| | | |
| | | |
| | | |
| | | |

NOTE: THE LOG OF SUBSURFACE CONDITIONS SHOWN HEREON APPLIES ONLY AT THE SPECIFIC BORING OR TRENCH LOCATION AND AT THE DATE INDICATED. IT IS NOT WARRANTED TO BE REPRESENTATIVE OF SUBSURFACE CONDITIONS AT OTHER LOCATIONS AND TIMES.

| DEPTH IN FEET | SAMPLE NO. | LITHOLOGY | GROUNDWATER | SOIL CLASS (USCS) | TEST PIT TP-1 | | PENETRATION RESISTANCE (BLOWS/FT.) | DRY DENSITY (P.C.F.) | MOISTURE CONTENT (%) |
|----------------------|---------------|-----------|-------------|-------------------------|---|----------------------------------|--|-------------------------|-------------------------|
| | | | | | ELEV. (MSL.) <u>1472</u> | DATE COMPLETED <u>02/23/2021</u> | | | |
| | | | | | EQUIPMENT <u>BACKHOE</u> | | BY: <u>Weidman</u> | | |
| MATERIAL DESCRIPTION | | | | | | | | | |
| 0 | | | | SM | ALLUVIUM (Qa) Silty SAND, loose, dry, dark brown; fine to medium sand; rootlets; grass at surface - Becomes medium dense, damp; some coarse sand | | | | |
| 2 | | | | ML | Sandy SILT, medium dense, damp, strong brown; fine to medium sand - Becomes fine to coarse sand | | | | |
| 4 | | | | SW | Well-graded SAND with silt, medium dense, moist, very dark brown; fine to coarse sand; some silt; weathering rinds on granitic grains - Becomes dark reddish brown | | | | |
| 6 | | | | | | | | | |
| 8 | | | | | | | | | |
| 10 | | | | | | | | | |
| 12 | | | | | | | | | |
| 14 | | | | | Total Depth = 14' Groundwater not encountered Backfilled with cuttings 2/23/2021 | | | | |

Figure A-5,
Log of Test Pit TP-1, Page 1 of 1

BORING LOGS.GPJ

| | | | | | | |
|----------------|--|-----------------------------|--|-------------------------------|--|--------------------------------|
| SAMPLE SYMBOLS | | ... SAMPLING UNSUCCESSFUL | | ... STANDARD PENETRATION TEST | | ... DRIVE SAMPLE (UNDISTURBED) |
| | | ... DISTURBED OR BAG SAMPLE | | ... CHUNK SAMPLE | | ... WATER TABLE OR SEEPAGE |

NOTE: THE LOG OF SUBSURFACE CONDITIONS SHOWN HEREON APPLIES ONLY AT THE SPECIFIC BORING OR TRENCH LOCATION AND AT THE DATE INDICATED. IT IS NOT WARRANTED TO BE REPRESENTATIVE OF SUBSURFACE CONDITIONS AT OTHER LOCATIONS AND TIMES.







| DEPTH IN FEET | SAMPLE NO. | LITHOLOGY | GROUNDWATER | SOIL CLASS (USCS) | TEST PIT TP-2 | | PENETRATION RESISTANCE (BLOWS/FT.) | DRY DENSITY (P.C.F.) | MOISTURE CONTENT (%) | |
|---------------------|---------------|---|-------------|-------------------------|--|----------------------------------|--|-------------------------|-------------------------|-----|
| | | | | | ELEV. (MSL.) <u>1478</u> | DATE COMPLETED <u>02/23/2021</u> | | | | |
| | | | | | EQUIPMENT <u>BACKHOE</u> BY: <u>Weidman</u> | | | | | |
| | | | | | MATERIAL DESCRIPTION | | | | | |
| 0 | TP-2@0-3' |  | | SM | ALLUVIUM (Qa) Silty SAND, loose, dry, dark brown; fine to medium sand; rootlets; grass at surface - Becomes medium dense, damp; some coarse sand Total Depth = 3' Groundwater not encountered Backfilled with cuttings 2/23/2021 | | | | | |
| 2 | | | | | | | | | 107.8 | 5.2 |
| | | | | | | | | 115.9 | 14.2 | |

Figure A-6,
Log of Test Pit TP-2, Page 1 of 1

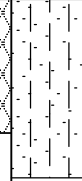
BORING LOGS.GPJ

| | | | |
|----------------|---|---|--|
| SAMPLE SYMBOLS |  ... SAMPLING UNSUCCESSFUL |  ... STANDARD PENETRATION TEST |  ... DRIVE SAMPLE (UNDISTURBED) |
| |  ... DISTURBED OR BAG SAMPLE |  ... CHUNK SAMPLE |  ... WATER TABLE OR SEEPAGE |

NOTE: THE LOG OF SUBSURFACE CONDITIONS SHOWN HEREON APPLIES ONLY AT THE SPECIFIC BORING OR TRENCH LOCATION AND AT THE DATE INDICATED. IT IS NOT WARRANTED TO BE REPRESENTATIVE OF SUBSURFACE CONDITIONS AT OTHER LOCATIONS AND TIMES.







| DEPTH IN FEET | SAMPLE NO. | LITHOLOGY | GROUNDWATER | SOIL CLASS (USCS) | TEST PIT TP-3 | | PENETRATION RESISTANCE (BLOWS/FT.) | DRY DENSITY (P.C.F.) | MOISTURE CONTENT (%) | |
|---------------------|---------------|---|-------------|-------------------------|--|----------------------------------|--|-------------------------|-------------------------|-----|
| | | | | | ELEV. (MSL.) <u>1473</u> | DATE COMPLETED <u>02/23/2021</u> | | | | |
| | | | | | EQUIPMENT <u>BACKHOE</u> BY: <u>Weidman</u> | | | | | |
| | | | | | MATERIAL DESCRIPTION | | | | | |
| 0 | FP-3@0-3' |  | | SM | ALLUVIUM (Qa) Silty SAND, loose, dry, dark brown; fine to medium sand; rootlets; grass at surface - Becomes medium dense, damp; some coarse sand Total Depth = 3' Groundwater not encountered Backfilled with cuttings 2/23/2021 | | | | | |
| 2 | | | | | | | | | 108.5 | 6.6 |
| | | | | | | | | 116.0 | 13.5 | |

Figure A-7,
Log of Test Pit TP-3, Page 1 of 1

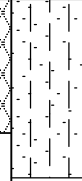
BORING LOGS.GPJ

| | | | |
|----------------|---|---|--|
| SAMPLE SYMBOLS |  ... SAMPLING UNSUCCESSFUL |  ... STANDARD PENETRATION TEST |  ... DRIVE SAMPLE (UNDISTURBED) |
| |  ... DISTURBED OR BAG SAMPLE |  ... CHUNK SAMPLE |  ... WATER TABLE OR SEEPAGE |

NOTE: THE LOG OF SUBSURFACE CONDITIONS SHOWN HEREON APPLIES ONLY AT THE SPECIFIC BORING OR TRENCH LOCATION AND AT THE DATE INDICATED. IT IS NOT WARRANTED TO BE REPRESENTATIVE OF SUBSURFACE CONDITIONS AT OTHER LOCATIONS AND TIMES.







| DEPTH IN FEET | SAMPLE NO. | LITHOLOGY | GROUNDWATER | SOIL CLASS (USCS) | TEST PIT TP-4 | | PENETRATION RESISTANCE (BLOWS/FT.) | DRY DENSITY (P.C.F.) | MOISTURE CONTENT (%) |
|---------------------|---------------|---|-------------|-------------------------|--|----------------------------------|--|-------------------------|-------------------------|
| | | | | | ELEV. (MSL.) <u>1475</u> | DATE COMPLETED <u>02/23/2021</u> | | | |
| | | | | | EQUIPMENT <u>BACKHOE</u> BY: <u>Weidman</u> | | | | |
| | | | | | MATERIAL DESCRIPTION | | | | |
| 0 | TP-4@0-3' |  | | SM | ALLUVIUM (Qa) Silty SAND, loose, dry, dark brown; fine to medium sand; rootlets; grass at surface - Becomes medium dense, damp; some coarse sand Total Depth = 3' Groundwater not encountered Backfilled with cuttings 2/23/2021 | | | 109.3 | 9.0 |
| 2 | | | | | | | | 116.2 | 14.0 |

Figure A-8,
Log of Test Pit TP-4, Page 1 of 1

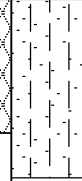
BORING LOGS.GPJ

| | | | |
|----------------|---|---|--|
| SAMPLE SYMBOLS |  ... SAMPLING UNSUCCESSFUL |  ... STANDARD PENETRATION TEST |  ... DRIVE SAMPLE (UNDISTURBED) |
| |  ... DISTURBED OR BAG SAMPLE |  ... CHUNK SAMPLE |  ... WATER TABLE OR SEEPAGE |

NOTE: THE LOG OF SUBSURFACE CONDITIONS SHOWN HEREON APPLIES ONLY AT THE SPECIFIC BORING OR TRENCH LOCATION AND AT THE DATE INDICATED. IT IS NOT WARRANTED TO BE REPRESENTATIVE OF SUBSURFACE CONDITIONS AT OTHER LOCATIONS AND TIMES.

| PERCOLATION TEST REPORT | | | | | | | |
|---|----------|--------------------|--------------------------|--------------------------|-------------------------------|-----------------------|-----------------------------|
| Project Name: | | Heacock St Parking | | | Project No.: | | T2925-22-01 |
| Test Hole No.: | | P-1 | | | Date Excavated: | | 2/23/2021 |
| Length of Test Pipe: | | 60.0 inches | | | Soil Classification: | | ML |
| Height of Pipe above Ground: | | 19.8 inches | | | Presoak Date: | | 2/23/2021 |
| Depth of Test Hole: | | 40.2 inches | | | Perc Test Date: | | 2/24/2021 |
| Check for Sandy Soil Criteria Tested by: | | | | Weidman | Percolation Tested by: | | Weidman |
| Water level measured from BOTTOM of hole | | | | | | | |
| Sandy Soil Criteria Test | | | | | | | |
| Trial No. | Time | Time Interval | Total Elapsed Time (min) | Initial Water Level (in) | Final Water Level (in) | Δ in Water Level (in) | Percolation Rate (min/inch) |
| 1 | 8:50 AM | 25 | 25 | 10.2 | 9.1 | 1.1 | 23.1 |
| | 9:15 AM | | | | | | |
| 2 | 9:15 AM | 25 | 50 | 10.2 | 8.5 | 1.7 | 14.9 |
| | 9:40 AM | | | | | | |
| Soil Criteria: Normal | | | | | | | |
| Percolation Test | | | | | | | |
| Reading No. | Time | Time Interval | Total Elapsed Time (min) | Initial Water Head (in) | Final Water Head (in) | Δ in Water Level (in) | Percolation Rate (min/inch) |
| 1 | 9:43 AM | 30 | 30 | 10.2 | 8.6 | 1.6 | 19.2 |
| | 10:13 AM | | | | | | |
| 2 | 10:13 AM | 30 | 60 | 10.2 | 9.5 | 0.7 | 41.7 |
| | 10:43 AM | | | | | | |
| 3 | 10:43 AM | 30 | 90 | 10.2 | 8.9 | 1.3 | 22.7 |
| | 11:13 AM | | | | | | |
| 4 | 11:13 AM | 30 | 120 | 10.2 | 8.3 | 1.9 | 15.6 |
| | 11:43 AM | | | | | | |
| 5 | 11:43 AM | 30 | 150 | 10.2 | 9.6 | 0.6 | 50.0 |
| | 12:13 PM | | | | | | |
| 6 | 12:13 PM | 30 | 180 | 10.2 | 9.0 | 1.2 | 25.0 |
| | 12:43 PM | | | | | | |
| 7 | 12:43 PM | 30 | 210 | 10.2 | 8.9 | 1.3 | 22.7 |
| | 1:13 PM | | | | | | |
| 8 | 1:13 PM | 30 | 240 | 10.2 | 8.9 | 1.3 | 22.7 |
| | 1:43 PM | | | | | | |
| 9 | 1:43 PM | 30 | 270 | 10.2 | 9.5 | 0.7 | 41.7 |
| | 2:13 PM | | | | | | |
| 10 | 2:13 PM | 30 | 300 | 10.2 | 9.1 | 1.1 | 27.8 |
| | 2:43 PM | | | | | | |
| 11 | 2:43 PM | 30 | 330 | 10.2 | 8.5 | 1.7 | 17.9 |
| | 3:13 PM | | | | | | |
| 12 | 3:13 PM | 30 | 360 | 10.2 | 8.8 | 1.4 | 20.8 |
| | 3:43 PM | | | | | | |
| Infiltration Rate (in/hr): | | | 0.5 | | | | |
| Radius of test hole (in): | | | 4 | Figure A-9 | | | |
| Average Head (in): | | | 9.5 | | | | |

| PERCOLATION TEST REPORT | | | | | | | |
|---|----------|---------------------|--------------------------|--------------------------|-------------------------------|-----------------------|-----------------------------|
| Project Name: | | Heacock St Parking | | | Project No.: | | T2925-22-01 |
| Test Hole No.: | | P-2 | | | Date Excavated: | | 2/23/2021 |
| Length of Test Pipe: | | 60.0 inches | | | Soil Classification: | | ML |
| Height of Pipe above Ground: | | 12.5 inches | | | Presoak Date: | | 2/23/2021 |
| Depth of Test Hole: | | 47.5 inches | | | Perc Test Date: | | 2/24/2021 |
| Check for Sandy Soil Criteria Tested by: | | | | Weidman | Percolation Tested by: | | Weidman |
| Water level measured from BOTTOM of hole | | | | | | | |
| Sandy Soil Criteria Test | | | | | | | |
| Trial No. | Time | Time Interval (min) | Total Elapsed Time (min) | Initial Water Level (in) | Final Water Level (in) | Δ in Water Level (in) | Percolation Rate (min/inch) |
| 1 | 8:52 AM | 25 | 25 | 11.5 | 9.6 | 1.9 | 13.0 |
| | 9:17 AM | | | | | | |
| 2 | 9:17 AM | 25 | 50 | 11.5 | 8.5 | 3.0 | 8.3 |
| | 9:42 AM | | | | | | |
| Soil Criteria: Normal | | | | | | | |
| Percolation Test | | | | | | | |
| Reading No. | Time | Time Interval (min) | Total Elapsed Time (min) | Initial Water Head (in) | Final Water Head (in) | Δ in Water Level (in) | Percolation Rate (min/inch) |
| 1 | 9:45 AM | 30 | 30 | 11.5 | 9.0 | 2.5 | 11.9 |
| | 10:15 AM | | | | | | |
| 2 | 10:15 AM | 30 | 60 | 11.5 | 10.8 | 0.7 | 41.7 |
| | 10:45 AM | | | | | | |
| 3 | 10:45 AM | 30 | 90 | 11.5 | 10.2 | 1.3 | 22.7 |
| | 11:15 AM | | | | | | |
| 4 | 11:15 AM | 30 | 120 | 11.5 | 10.2 | 1.3 | 22.7 |
| | 11:45 AM | | | | | | |
| 5 | 11:45 AM | 30 | 150 | 11.5 | 10.2 | 1.3 | 22.7 |
| | 12:15 PM | | | | | | |
| 6 | 12:15 PM | 30 | 180 | 11.5 | 10.2 | 1.3 | 22.7 |
| | 12:45 PM | | | | | | |
| 7 | 12:45 PM | 30 | 210 | 11.5 | 10.2 | 1.3 | 22.7 |
| | 1:15 PM | | | | | | |
| 8 | 1:15 PM | 30 | 240 | 11.5 | 10.2 | 1.3 | 22.7 |
| | 1:45 PM | | | | | | |
| 9 | 1:45 PM | 30 | 270 | 11.5 | 10.2 | 1.3 | 22.7 |
| | 2:15 PM | | | | | | |
| 10 | 2:15 PM | 30 | 300 | 11.5 | 10.2 | 1.3 | 22.7 |
| | 2:45 PM | | | | | | |
| 11 | 2:45 PM | 30 | 330 | 11.5 | 10.0 | 1.6 | 19.2 |
| | 3:15 PM | | | | | | |
| 12 | 3:15 PM | 30 | 360 | 11.5 | 10.1 | 1.4 | 20.8 |
| | 3:45 PM | | | | | | |
| Infiltration Rate (in/hr): | | | 0.5 | | | | |
| Radius of test hole (in): | | | 4 | Figure A-10 | | | |
| Average Head (in): | | | 10.8 | | | | |

| PERCOLATION TEST REPORT | | | | | | | |
|---|----------|---------------------|--------------------------|--------------------------|-------------------------------|-----------------------|-----------------------------|
| Project Name: | | Heacock St Parking | | | Project No.: | | T2925-22-01 |
| Test Hole No.: | | P-3 | | | Date Excavated: | | 2/23/2021 |
| Length of Test Pipe: | | 60.0 inches | | | Soil Classification: | | ML |
| Height of Pipe above Ground: | | 13.2 inches | | | Presoak Date: | | 2/23/2021 |
| Depth of Test Hole: | | 46.8 inches | | | Perc Test Date: | | 2/24/2021 |
| Check for Sandy Soil Criteria Tested by: | | | | Weidman | Percolation Tested by: | | Weidman |
| Water level measured from BOTTOM of hole | | | | | | | |
| Sandy Soil Criteria Test | | | | | | | |
| Trial No. | Time | Time Interval (min) | Total Elapsed Time (min) | Initial Water Level (in) | Final Water Level (in) | Δ in Water Level (in) | Percolation Rate (min/inch) |
| 1 | 8:54 AM | 25 | 25 | 10.8 | 8.3 | 2.5 | 9.9 |
| | 9:19 AM | | | | | | |
| 2 | 9:19 AM | 25 | 50 | 10.8 | 8.3 | 2.5 | 9.9 |
| | 9:44 AM | | | | | | |
| Soil Criteria: Normal | | | | | | | |
| Percolation Test | | | | | | | |
| Reading No. | Time | Time Interval (min) | Total Elapsed Time (min) | Initial Water Head (in) | Final Water Head (in) | Δ in Water Level (in) | Percolation Rate (min/inch) |
| 1 | 9:47 AM | 30 | 30 | 10.8 | 6.5 | 4.3 | 6.9 |
| | 10:17 AM | | | | | | |
| 2 | 10:17 AM | 30 | 60 | 10.8 | 8.4 | 2.4 | 12.5 |
| | 10:47 AM | | | | | | |
| 3 | 10:47 AM | 30 | 90 | 10.8 | 7.6 | 3.2 | 9.3 |
| | 11:17 AM | | | | | | |
| 4 | 11:17 AM | 30 | 120 | 10.8 | 7.7 | 3.1 | 9.6 |
| | 11:47 AM | | | | | | |
| 5 | 11:47 AM | 30 | 150 | 10.8 | 7.8 | 3.0 | 10.0 |
| | 12:17 PM | | | | | | |
| 6 | 12:17 PM | 30 | 180 | 10.8 | 8.3 | 2.5 | 11.9 |
| | 12:47 PM | | | | | | |
| 7 | 12:47 PM | 30 | 210 | 10.8 | 8.2 | 2.6 | 11.4 |
| | 1:17 PM | | | | | | |
| 8 | 1:17 PM | 30 | 240 | 10.8 | 7.8 | 3.0 | 10.0 |
| | 1:47 PM | | | | | | |
| 9 | 1:47 PM | 30 | 270 | 10.8 | 7.6 | 3.2 | 9.3 |
| | 2:17 PM | | | | | | |
| 10 | 2:17 PM | 30 | 300 | 10.8 | 8.0 | 2.8 | 10.9 |
| | 2:47 PM | | | | | | |
| 11 | 2:47 PM | 30 | 330 | 10.8 | 7.7 | 3.1 | 9.6 |
| | 3:17 PM | | | | | | |
| 12 | 3:17 PM | 30 | 360 | 10.8 | 7.8 | 3.0 | 10.0 |
| | 3:47 PM | | | | | | |
| Infiltration Rate (in/hr): | | | 1.1 | | | | |
| Radius of test hole (in): | | | 4 | Figure A-11 | | | |
| Average Head (in): | | | 9.3 | | | | |

PERCOLATION TEST REPORT

| Project Name: | Heacock St Parking | | | Project No.: | T2925-22-01 | | |
|---|--------------------|---------------------|--------------------------|-------------------------------|------------------------|-----------------------|-----------------------------|
| Test Hole No.: | P-4 | | | Date Excavated: | 2/23/2021 | | |
| Length of Test Pipe: | 63.6 inches | | | Soil Classification: | ML | | |
| Height of Pipe above Ground: | 17.6 inches | | | Presoak Date: | 2/23/2021 | | |
| Depth of Test Hole: | 46.0 inches | | | Perc Test Date: | 2/24/2021 | | |
| Check for Sandy Soil Criteria Tested by: | Weidman | | | Percolation Tested by: | Weidman | | |
| Water level measured from BOTTOM of hole | | | | | | | |
| Sandy Soil Criteria Test | | | | | | | |
| Trial No. | Time | Time Interval (min) | Total Elapsed Time (min) | Initial Water Level (in) | Final Water Level (in) | Δ in Water Level (in) | Percolation Rate (min/inch) |
| 1 | 8:56 AM | 25 | 25 | 10.0 | 7.6 | 2.4 | 10.4 |
| | 9:21 AM | | | | | | |
| 2 | 9:21 AM | 25 | 50 | 10.0 | 8.0 | 1.9 | 13.0 |
| | 9:46 AM | | | | | | |
| Soil Criteria: Normal | | | | | | | |
| Percolation Test | | | | | | | |
| Reading No. | Time | Time Interval (min) | Total Elapsed Time (min) | Initial Water Head (in) | Final Water Head (in) | Δ in Water Level (in) | Percolation Rate (min/inch) |
| 1 | 9:49 AM | 30 | 30 | 10.0 | 6.4 | 3.6 | 8.3 |
| | 10:19 AM | | | | | | |
| 2 | 10:19 AM | 30 | 60 | 10.0 | 9.0 | 1.0 | 31.2 |
| | 10:49 AM | | | | | | |
| 3 | 10:49 AM | 30 | 90 | 10.0 | 7.8 | 2.2 | 13.9 |
| | 11:19 AM | | | | | | |
| 4 | 11:19 AM | 30 | 120 | 10.0 | 7.6 | 2.4 | 12.5 |
| | 11:49 AM | | | | | | |
| 5 | 11:49 AM | 30 | 150 | 10.0 | 7.1 | 2.9 | 10.4 |
| | 12:19 PM | | | | | | |
| 6 | 12:19 PM | 30 | 180 | 10.0 | 7.4 | 2.5 | 11.9 |
| | 12:49 PM | | | | | | |
| 7 | 12:49 PM | 30 | 210 | 10.0 | 7.8 | 2.2 | 13.9 |
| | 1:19 PM | | | | | | |
| 8 | 1:19 PM | 30 | 240 | 10.0 | 7.7 | 2.3 | 13.2 |
| | 1:49 PM | | | | | | |
| 9 | 1:49 PM | 30 | 270 | 10.0 | 7.1 | 2.9 | 10.4 |
| | 2:19 PM | | | | | | |
| 10 | 2:19 PM | 30 | 300 | 10.0 | 7.3 | 2.6 | 11.4 |
| | 2:49 PM | | | | | | |
| 11 | 2:49 PM | 30 | 330 | 10.0 | 7.8 | 2.2 | 13.9 |
| | 3:19 PM | | | | | | |
| 12 | 3:19 PM | 30 | 360 | 10.0 | 7.6 | 2.4 | 12.5 |
| | 3:49 PM | | | | | | |
| Infiltration Rate (in/hr): | 0.9 | | | | | | |
| Radius of test hole (in): | 4 | | | | | | Figure A-12 |
| Average Head (in): | 8.8 | | | | | | |

APPENDIX

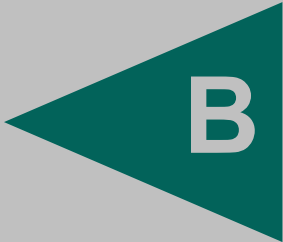

B

APPENDIX B

LABORATORY TESTING

We performed laboratory tests in accordance with current, generally accepted test methods of ASTM International (ASTM) or other suggested procedures. We analyzed selected soil samples for maximum dry density and optimum moisture content, sulfate content, grain size distribution, and R-value. The results of the laboratory tests are presented on Figures B-1 through B-4.

SUMMARY OF R-VALUE TEST RESULTS (ASTM D 2844-99)

| Sample Location | Soil Description | R-Value |
|-------------------|-----------------------|---------|
| P-3,TP-2,TP-3 Mix | Silty Sand, some clay | 35 |

Sample No:

| | |
|----------------------------|-------------------------------|
| P3&TP2@0-3' MIX | Silty SAND (SM), strong brown |
|----------------------------|-------------------------------|

| TEST NO. | | 1 | 2 | 3 | 4 | 5 | 6 |
|----------------------------|-------|-------|-------|-------|-------|---|-------|
| Wt. Compacted Soil + Mold | (g) | 6383 | 6389 | 6313 | 6190 | | |
| Weight of Mold | (g) | 4277 | 4277 | 4277 | 4277 | | |
| Net Weight of Soil | (g) | 2106 | 2113 | 2036 | 1913 | | |
| Wet Weight of Soil + Cont. | (g) | 819.6 | 749.4 | 732.7 | 713.1 | | 592.8 |
| Dry Weight of Soil + Cont. | (g) | 771.8 | 700.9 | 702.1 | 692.0 | | 570.7 |
| Weight of Container | (g) | 258.1 | 257.8 | 258.6 | 259.2 | | 258.1 |
| Moisture Content | (%) | 9.3 | 10.9 | 6.9 | 4.9 | | 7.1 |
| Wet Density | (pcf) | 139.4 | 139.9 | 134.8 | 126.7 | | |
| Dry Density | (pcf) | 127.6 | 126.1 | 126.1 | 120.8 | | 0.0 |

Maximum Dry Density (pcf) 128.0

Optimum Moisture Content (%) 8.0

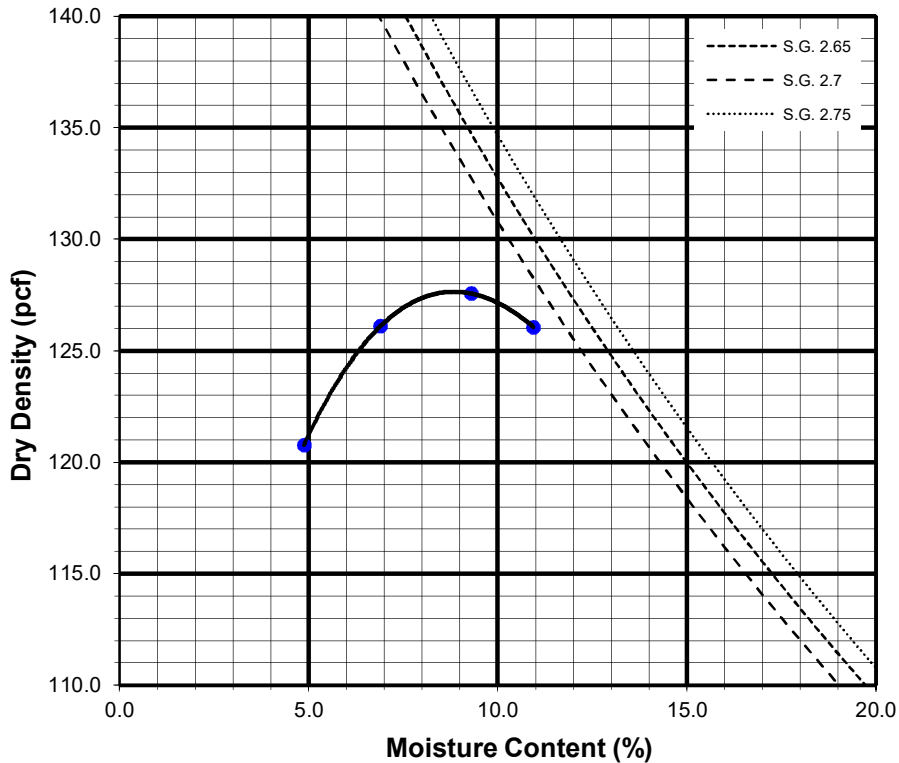

Preparation Method: A



COMPACTION CHARACTERISTICS USING MODIFIED EFFORT TEST RESULTS

ASTM D-1557

Checked by:

Project No.: T2925-22-01
 HEACOCK LOGISTICS PARKING, APN 316-211-014
 HEACOCK AVE AT PERRIS VALLEY STORM DRAIN
 MORENO VALLEY, CALIFORNIA

Mar 21

Figure B-1

SUMMARY OF LABORATORY WATER SOLUBLE SULFATE TEST RESULTS
CALIFORNIA TEST NO. 417

| Sample No. | Water Soluble Sulfate (% SQ ₄) | Sulfate Exposure* |
|------------|---|-------------------|
| P1@0-3' | 0.000 | S0 |
| | | |
| | | |

| | | |
|--|---------------------------------|--|
|  GEOCON | CORROSIVITY TEST RESULTS | Project No.: T2925-22-01 |
| | | HEACOCK LOGISTICS, APN 316-211-014 HEACOCK AVE AT PERRIS VALLEY SD MORENO VALLEY, CALIFORNIA |
| | Checked by: _____ | Mar 21 Figure B-2 |

| | | | | | |
|--------|------|--------|--------|------|---------------|
| GRAVEL | | SAND | | | SILT AND CLAY |
| COARSE | FINE | COARSE | MEDIUM | FINE | |

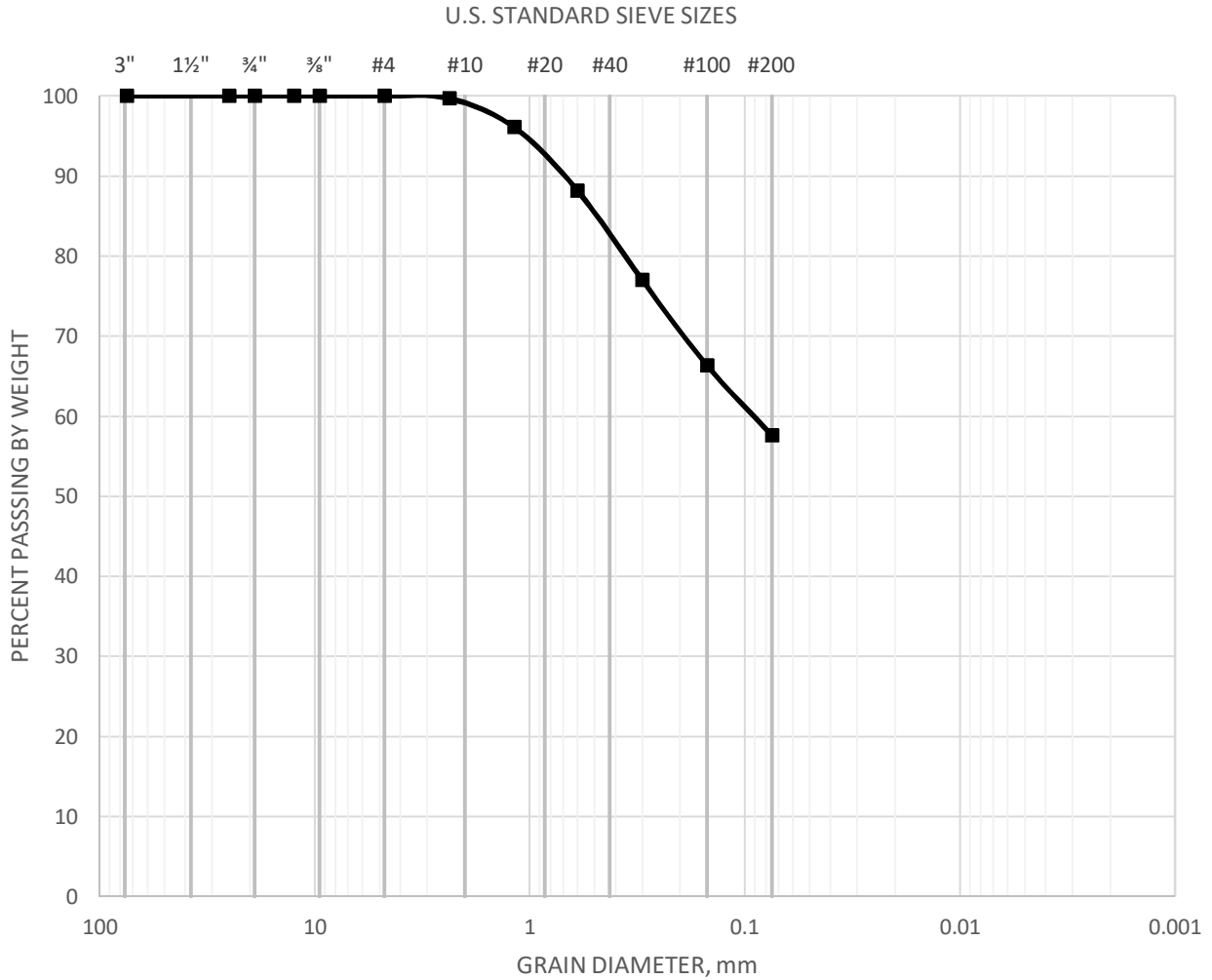

| SAMPLE | CLASSIFICATION | D60 | D30 | D10 |
|-------------|-------------------------------|-----|-----|-----|
| P1&P2@4'mix | Sandy SILT (ML), strong brown | 0 | 0 | 0 |



GRAIN SIZE DISTRIBUTION
ASTM D-2488

Checked by:

Project No.: T2925-22-01
HEACOCK LOGISTICS PARKING, APN 316-211-014
HEACOCK AVE AT PERRIS VALLEY STORM DRAIN
MORENO VALLEY, CALIFORNIA

Mar 21 Figure B-3

| | | | | | |
|--------|------|--------|--------|------|---------------|
| GRAVEL | | SAND | | | SILT AND CLAY |
| COARSE | FINE | COARSE | MEDIUM | FINE | |

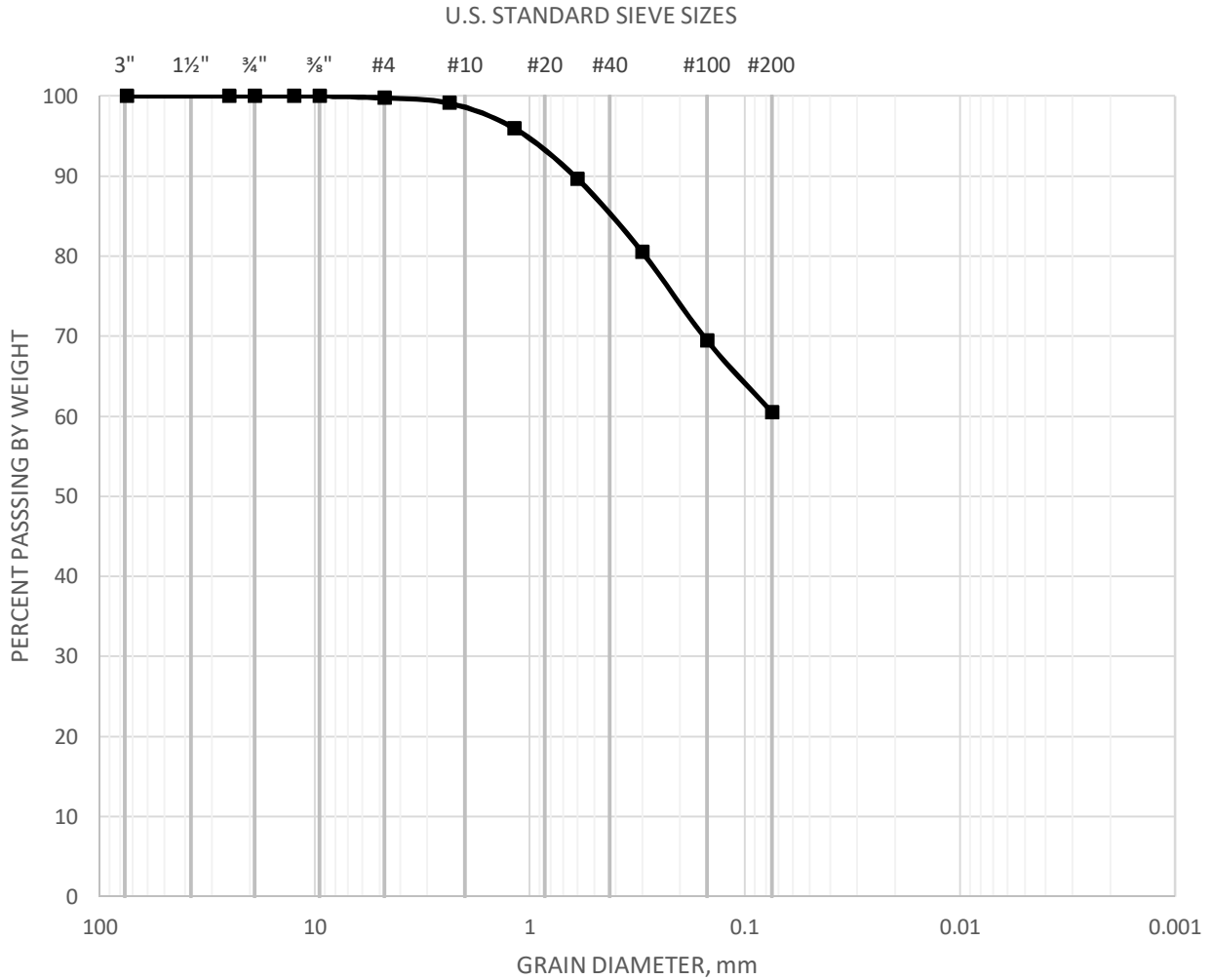

| SAMPLE | CLASSIFICATION | D60 | D30 | D10 |
|-------------|-------------------------------|-----|-----|-----|
| P3&P4@4'mix | Sandy SILT (ML), strong brown | 0 | 0 | 0 |

| | | |
|---|--------------------------------|---|
|  | GRAIN SIZE DISTRIBUTION | Project No.: T2925-22-01 |
| | ASTM D-2488 | HEACOCK LOGISTICS PARKING, APN 316-211-014 HEACOCK AVE AT PERRIS VALLEY STORM DRAIN MORENO VALLEY, CALIFORNIA |
| | Checked by: | Mar 21 Figure B-4 |

APPENDIX



C

APPENDIX C

RECOMMENDED GRADING SPECIFICATIONS

FOR

HEACOCK LOGISTICS PARKING PROJECT
APN 316-211-014, HEACOCK AVENUE
AT PERRIS VALLEY STORM DRAIN
MORENO VALLEY, CALIFORNIA

PROJECT NO. T2925-22-01

RECOMMENDED GRADING SPECIFICATIONS

1. GENERAL

- 1.1 These Recommended Grading Specifications shall be used in conjunction with the Geotechnical Report for the project prepared by Geocon. The recommendations contained in the text of the Geotechnical Report are a part of the earthwork and grading specifications and shall supersede the provisions contained hereinafter in the case of conflict.
- 1.2 Prior to the commencement of grading, a geotechnical consultant (Consultant) shall be employed for the purpose of observing earthwork procedures and testing the fills for substantial conformance with the recommendations of the Geotechnical Report and these specifications. The Consultant should provide adequate testing and observation services so that they may assess whether, in their opinion, the work was performed in substantial conformance with these specifications. It shall be the responsibility of the Contractor to assist the Consultant and keep them apprised of work schedules and changes so that personnel may be scheduled accordingly.
- 1.3 It shall be the sole responsibility of the Contractor to provide adequate equipment and methods to accomplish the work in accordance with applicable grading codes or agency ordinances, these specifications and the approved grading plans. If, in the opinion of the Consultant, unsatisfactory conditions such as questionable soil materials, poor moisture condition, inadequate compaction, and/or adverse weather result in a quality of work not in conformance with these specifications, the Consultant will be empowered to reject the work and recommend to the Owner that grading be stopped until the unacceptable conditions are corrected.

2. DEFINITIONS

- 2.1 **Owner** shall refer to the owner of the property or the entity on whose behalf the grading work is being performed and who has contracted with the Contractor to have grading performed.
- 2.2 **Contractor** shall refer to the Contractor performing the site grading work.
- 2.3 **Civil Engineer** or **Engineer of Work** shall refer to the California licensed Civil Engineer or consulting firm responsible for preparation of the grading plans, surveying and verifying as-graded topography.
- 2.4 **Consultant** shall refer to the soil engineering and engineering geology consulting firm retained to provide geotechnical services for the project.

- 2.5 **Soil Engineer** shall refer to a California licensed Civil Engineer retained by the Owner, who is experienced in the practice of geotechnical engineering. The Soil Engineer shall be responsible for having qualified representatives on-site to observe and test the Contractor's work for conformance with these specifications.
- 2.6 **Engineering Geologist** shall refer to a California licensed Engineering Geologist retained by the Owner to provide geologic observations and recommendations during the site grading.
- 2.7 **Geotechnical Report** shall refer to a soil report (including all addenda) which may include a geologic reconnaissance or geologic investigation that was prepared specifically for the development of the project for which these Recommended Grading Specifications are intended to apply.

3. MATERIALS

- 3.1 Materials for compacted fill shall consist of any soil excavated from the cut areas or imported to the site that, in the opinion of the Consultant, is suitable for use in construction of fills. In general, fill materials can be classified as *soil* fills, *soil-rock* fills or *rock* fills, as defined below.
- 3.1.1 **Soil fills** are defined as fills containing no rocks or hard lumps greater than 12 inches in maximum dimension and containing at least 40 percent by weight of material smaller than $\frac{3}{4}$ inch in size.
- 3.1.2 **Soil-rock fills** are defined as fills containing no rocks or hard lumps larger than 4 feet in maximum dimension and containing a sufficient matrix of soil fill to allow for proper compaction of soil fill around the rock fragments or hard lumps as specified in Paragraph 6.2. **Oversize rock** is defined as material greater than 12 inches.
- 3.1.3 **Rock fills** are defined as fills containing no rocks or hard lumps larger than 3 feet in maximum dimension and containing little or no fines. Fines are defined as material smaller than $\frac{3}{4}$ inch in maximum dimension. The quantity of fines shall be less than approximately 20 percent of the rock fill quantity.
- 3.2 Material of a perishable, spongy, or otherwise unsuitable nature as determined by the Consultant shall not be used in fills.
- 3.3 Materials used for fill, either imported or on-site, shall not contain hazardous materials as defined by the California Code of Regulations, Title 22, Division 4, Chapter 30, Articles 9

and 10; 40CFR; and any other applicable local, state or federal laws. The Consultant shall not be responsible for the identification or analysis of the potential presence of hazardous materials. However, if observations, odors or soil discoloration cause Consultant to suspect the presence of hazardous materials, the Consultant may request from the Owner the termination of grading operations within the affected area. Prior to resuming grading operations, the Owner shall provide a written report to the Consultant indicating that the suspected materials are not hazardous as defined by applicable laws and regulations.

- 3.4 The outer 15 feet of *soil-rock* fill slopes, measured horizontally, should be composed of properly compacted *soil* fill materials approved by the Consultant. *Rock* fill may extend to the slope face, provided that the slope is not steeper than 2:1 (horizontal:vertical) and a soil layer no thicker than 12 inches is track-walked onto the face for landscaping purposes. This procedure may be utilized provided it is acceptable to the governing agency, Owner and Consultant.
- 3.5 Samples of soil materials to be used for fill should be tested in the laboratory by the Consultant to determine the maximum density, optimum moisture content, and, where appropriate, shear strength, expansion, and gradation characteristics of the soil.
- 3.6 During grading, soil or groundwater conditions other than those identified in the Geotechnical Report may be encountered by the Contractor. The Consultant shall be notified immediately to evaluate the significance of the unanticipated condition

4. CLEARING AND PREPARING AREAS TO BE FILLED

- 4.1 Areas to be excavated and filled shall be cleared and grubbed. Clearing shall consist of complete removal above the ground surface of trees, stumps, brush, vegetation, man-made structures, and similar debris. Grubbing shall consist of removal of stumps, roots, buried logs and other unsuitable material and shall be performed in areas to be graded. Roots and other projections exceeding 1½ inches in diameter shall be removed to a depth of 3 feet below the surface of the ground. Borrow areas shall be grubbed to the extent necessary to provide suitable fill materials.
- 4.2 Asphalt pavement material removed during clearing operations should be properly disposed at an approved off-site facility or in an acceptable area of the project evaluated by Geocon and the property owner. Concrete fragments that are free of reinforcing steel may be placed in fills, provided they are placed in accordance with Section 6.2 or 6.3 of this document.

- 4.3 After clearing and grubbing of organic matter and other unsuitable material, loose or porous soils shall be removed to the depth recommended in the Geotechnical Report. The depth of removal and compaction should be observed and approved by a representative of the Consultant. The exposed surface shall then be plowed or scarified to a minimum depth of 6 inches and until the surface is free from uneven features that would tend to prevent uniform compaction by the equipment to be used.
- 4.4 Where the slope ratio of the original ground is steeper than 5:1 (horizontal:vertical), or where recommended by the Consultant, the original ground should be benched in accordance with the following illustration.

TYPICAL BENCHING DETAIL

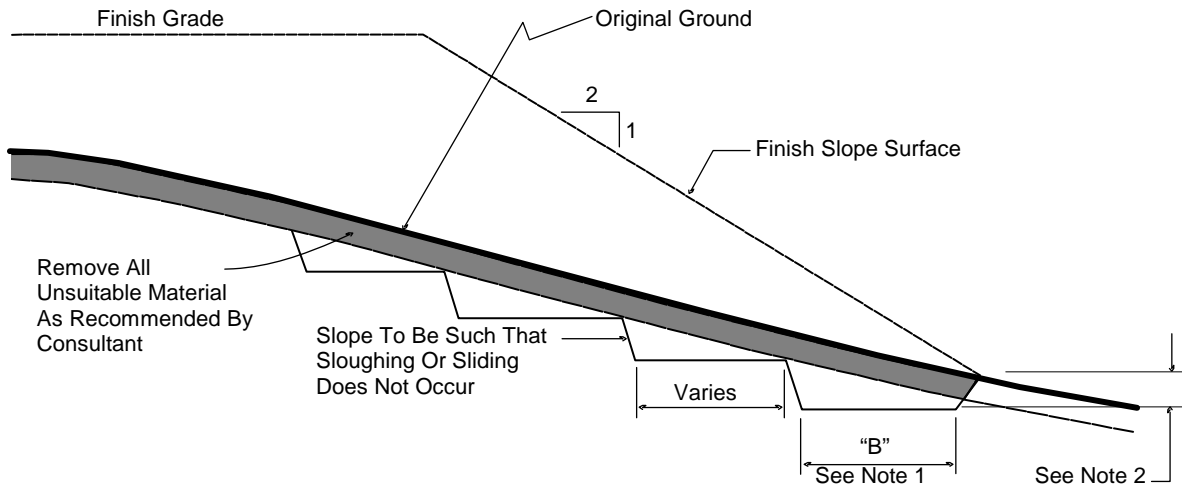

No Scale

- DETAIL NOTES: (1) Key width "B" should be a minimum of 10 feet, or sufficiently wide to permit complete coverage with the compaction equipment used. The base of the key should be graded horizontal, or inclined slightly into the natural slope.
- (2) The outside of the key should be below the topsoil or unsuitable surficial material and at least 2 feet into dense formational material. Where hard rock is exposed in the bottom of the key, the depth and configuration of the key may be modified as approved by the Consultant.

- 4.5 After areas to receive fill have been cleared and scarified, the surface should be moisture conditioned to achieve the proper moisture content, and compacted as recommended in Section 6 of these specifications.

5. COMPACTION EQUIPMENT

- 5.1 Compaction of *soil* or *soil-rock* fill shall be accomplished by sheepsfoot or segmented-steel wheeled rollers, vibratory rollers, multiple-wheel pneumatic-tired rollers, or other types of acceptable compaction equipment. Equipment shall be of such a design that it will be capable of compacting the *soil* or *soil-rock* fill to the specified relative compaction at the specified moisture content.
- 5.2 Compaction of *rock* fills shall be performed in accordance with Section 6.3.

6. PLACING, SPREADING AND COMPACTION OF FILL MATERIAL

- 6.1 *Soil* fill, as defined in Paragraph 3.1.1, shall be placed by the Contractor in accordance with the following recommendations:
- 6.1.1 *Soil* fill shall be placed by the Contractor in layers that, when compacted, should generally not exceed 8 inches. Each layer shall be spread evenly and shall be thoroughly mixed during spreading to obtain uniformity of material and moisture in each layer. The entire fill shall be constructed as a unit in nearly level lifts. Rock materials greater than 12 inches in maximum dimension shall be placed in accordance with Section 6.2 or 6.3 of these specifications.
- 6.1.2 In general, the *soil* fill shall be compacted at a moisture content at or above the optimum moisture content as determined by ASTM D 1557.
- 6.1.3 When the moisture content of *soil* fill is below that specified by the Consultant, water shall be added by the Contractor until the moisture content is in the range specified.
- 6.1.4 When the moisture content of the *soil* fill is above the range specified by the Consultant or too wet to achieve proper compaction, the *soil* fill shall be aerated by the Contractor by blading/mixing, or other satisfactory methods until the moisture content is within the range specified.
- 6.1.5 After each layer has been placed, mixed, and spread evenly, it shall be thoroughly compacted by the Contractor to a relative compaction of at least 90 percent. Relative compaction is defined as the ratio (expressed in percent) of the in-place dry density of the compacted fill to the maximum laboratory dry density as determined in accordance with ASTM D 1557. Compaction shall be continuous over the entire area, and compaction equipment shall make sufficient passes so that the specified minimum relative compaction has been achieved throughout the entire fill.

- 6.1.6 Where practical, soils having an Expansion Index greater than 50 should be placed at least 3 feet below finish pad grade and should be compacted at a moisture content generally 2 to 4 percent greater than the optimum moisture content for the material.
 - 6.1.7 Properly compacted *soil* fill shall extend to the design surface of fill slopes. To achieve proper compaction, it is recommended that fill slopes be over-built by at least 3 feet and then cut to the design grade. This procedure is considered preferable to track-walking of slopes, as described in the following paragraph.
 - 6.1.8 As an alternative to over-building of slopes, slope faces may be back-rolled with a heavy-duty loaded sheepsfoot or vibratory roller at maximum 4-foot fill height intervals. Upon completion, slopes should then be track-walked with a D-8 dozer or similar equipment, such that a dozer track covers all slope surfaces at least twice.
- 6.2 *Soil-rock* fill, as defined in Paragraph 3.1.2, shall be placed by the Contractor in accordance with the following recommendations:
- 6.2.1 Rocks larger than 12 inches but less than 4 feet in maximum dimension may be incorporated into the compacted *soil* fill, but shall be limited to the area measured 15 feet minimum horizontally from the slope face and 5 feet below finish grade or 3 feet below the deepest utility, whichever is deeper.
 - 6.2.2 Rocks or rock fragments up to 4 feet in maximum dimension may either be individually placed or placed in windrows. Under certain conditions, rocks or rock fragments up to 10 feet in maximum dimension may be placed using similar methods. The acceptability of placing rock materials greater than 4 feet in maximum dimension shall be evaluated during grading as specific cases arise and shall be approved by the Consultant prior to placement.
 - 6.2.3 For individual placement, sufficient space shall be provided between rocks to allow for passage of compaction equipment.
 - 6.2.4 For windrow placement, the rocks should be placed in trenches excavated in properly compacted *soil* fill. Trenches should be approximately 5 feet wide and 4 feet deep in maximum dimension. The voids around and beneath rocks should be filled with approved granular soil having a Sand Equivalent of 30 or greater and should be compacted by flooding. Windrows may also be placed utilizing an "open-face" method in lieu of the trench procedure, however, this method should first be approved by the Consultant.

- 6.2.5 Windrows should generally be parallel to each other and may be placed either parallel to or perpendicular to the face of the slope depending on the site geometry. The minimum horizontal spacing for windrows shall be 12 feet center-to-center with a 5-foot stagger or offset from lower courses to next overlying course. The minimum vertical spacing between windrow courses shall be 2 feet from the top of a lower windrow to the bottom of the next higher windrow.
- 6.2.6 Rock placement, fill placement and flooding of approved granular soil in the windrows should be continuously observed by the Consultant.
- 6.3 *Rock* fills, as defined in Section 3.1.3, shall be placed by the Contractor in accordance with the following recommendations:
- 6.3.1 The base of the *rock* fill shall be placed on a sloping surface (minimum slope of 2 percent). The surface shall slope toward suitable subdrainage outlet facilities. The *rock* fills shall be provided with subdrains during construction so that a hydrostatic pressure buildup does not develop. The subdrains shall be permanently connected to controlled drainage facilities to control post-construction infiltration of water.
- 6.3.2 *Rock* fills shall be placed in lifts not exceeding 3 feet. Placement shall be by rock trucks traversing previously placed lifts and dumping at the edge of the currently placed lift. Spreading of the *rock* fill shall be by dozer to facilitate *seating* of the rock. The *rock* fill shall be watered heavily during placement. Watering shall consist of water trucks traversing in front of the current rock lift face and spraying water continuously during rock placement. Compaction equipment with compactive energy comparable to or greater than that of a 20-ton steel vibratory roller or other compaction equipment providing suitable energy to achieve the required compaction or deflection as recommended in Paragraph 6.3.3 shall be utilized. The number of passes to be made should be determined as described in Paragraph 6.3.3. Once a *rock* fill lift has been covered with *soil* fill, no additional *rock* fill lifts will be permitted over the *soil* fill.
- 6.3.3 Plate bearing tests, in accordance with ASTM D 1196, may be performed in both the compacted *soil* fill and in the *rock* fill to aid in determining the required minimum number of passes of the compaction equipment. If performed, a minimum of three plate bearing tests should be performed in the properly compacted *soil* fill (minimum relative compaction of 90 percent). Plate bearing tests shall then be performed on areas of *rock* fill having two passes, four passes and six passes of the compaction equipment, respectively. The number of passes required for the *rock* fill shall be determined by comparing the results of the plate bearing tests for the *soil* fill and the *rock* fill and by evaluating the deflection

variation with number of passes. The required number of passes of the compaction equipment will be performed as necessary until the plate bearing deflections are equal to or less than that determined for the properly compacted *soil* fill. In no case will the required number of passes be less than two.

- 6.3.4 A representative of the Consultant should be present during *rock* fill operations to observe that the minimum number of “passes” have been obtained, that water is being properly applied and that specified procedures are being followed. The actual number of plate bearing tests will be determined by the Consultant during grading.
- 6.3.5 Test pits shall be excavated by the Contractor so that the Consultant can state that, in their opinion, sufficient water is present and that voids between large rocks are properly filled with smaller rock material. In-place density testing will not be required in the *rock* fills.
- 6.3.6 To reduce the potential for “piping” of fines into the *rock* fill from overlying *soil* fill material, a 2-foot layer of graded filter material shall be placed above the uppermost lift of *rock* fill. The need to place graded filter material below the *rock* should be determined by the Consultant prior to commencing grading. The gradation of the graded filter material will be determined at the time the *rock* fill is being excavated. Materials typical of the *rock* fill should be submitted to the Consultant in a timely manner, to allow design of the graded filter prior to the commencement of *rock* fill placement.
- 6.3.7 *Rock* fill placement should be continuously observed during placement by the Consultant.

7. SUBDRAINS

- 7.1 The geologic units on the site may have permeability characteristics and/or fracture systems that could be susceptible under certain conditions to seepage. The use of canyon subdrains may be necessary to mitigate the potential for adverse impacts associated with seepage conditions. Canyon subdrains with lengths in excess of 500 feet or extensions of existing offsite subdrains should use 8-inch-diameter pipes. Canyon subdrains less than 500 feet in length should use 6-inch-diameter pipes.

TYPICAL CANYON DRAIN DETAIL

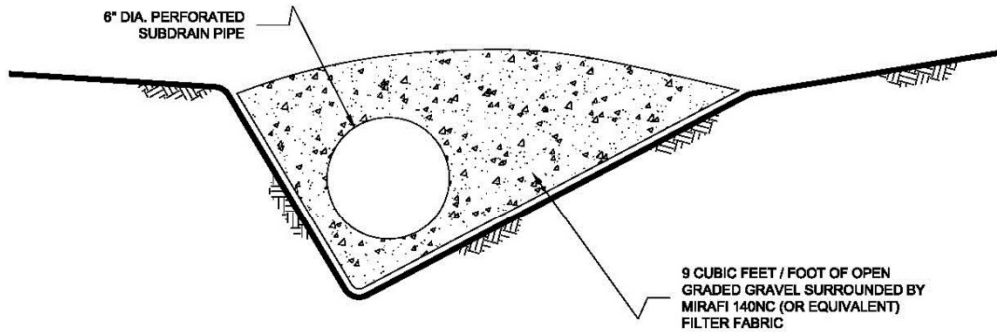
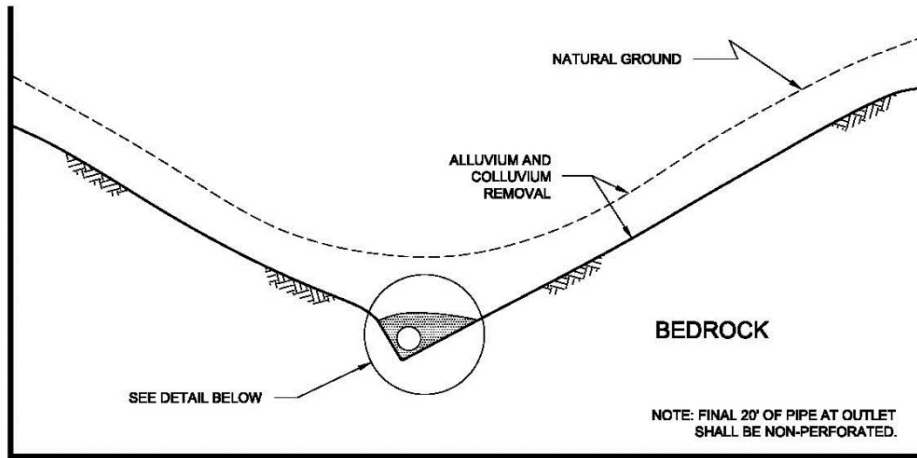

NOTES:

- 1.....8-INCH DIAMETER, SCHEDULE 80 PVC PERFORATED PIPE FOR FILLS IN EXCESS OF 100-FEET IN DEPTH OR A PIPE LENGTH OF LONGER THAN 500 FEET.
- 2.....6-INCH DIAMETER, SCHEDULE 40 PVC PERFORATED PIPE FOR FILLS LESS THAN 100-FEET IN DEPTH OR A PIPE LENGTH SHORTER THAN 500 FEET.

NO SCALE

7.2 Slope drains within stability fill keyways should use 4-inch-diameter (or larger) pipes.

TYPICAL STABILITY FILL DETAIL

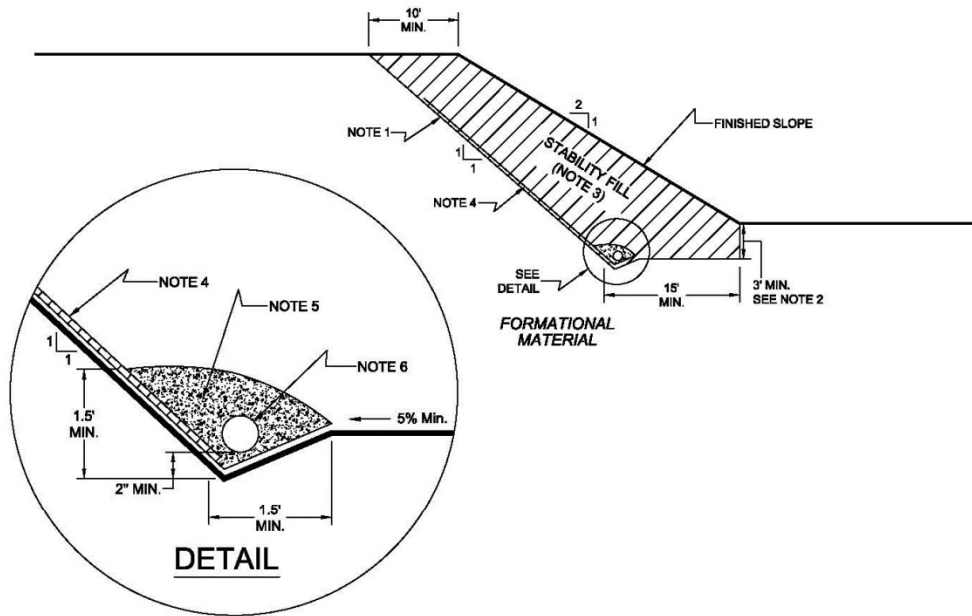

NOTES:

- 1.....EXCAVATE BACKCUT AT 1:1 INCLINATION (UNLESS OTHERWISE NOTED).
- 2.....BASE OF STABILITY FILL TO BE 3 FEET INTO FORMATIONAL MATERIAL, SLOPING A MINIMUM 5% INTO SLOPE.
- 3.....STABILITY FILL TO BE COMPOSED OF PROPERLY COMPACTED GRANULAR SOIL.
- 4.....CHIMNEY DRAINS TO BE APPROVED PREFABRICATED CHIMNEY DRAIN PANELS (MIRADRAIN G200N OR EQUIVALENT) SPACED APPROXIMATELY 20 FEET CENTER TO CENTER AND 4 FEET WIDE. CLOSER SPACING MAY BE REQUIRED IF SEEPAGE IS ENCOUNTERED.
- 5.....FILTER MATERIAL TO BE 3/4-INCH, OPEN-GRADED CRUSHED ROCK ENCLOSED IN APPROVED FILTER FABRIC (MIRAFI 140NC).
- 6.....COLLECTOR PIPE TO BE 4-INCH MINIMUM DIAMETER, PERFORATED, THICK-WALLED PVC SCHEDULE 40 OR EQUIVALENT, AND SLOPED TO DRAIN AT 1 PERCENT MINIMUM TO APPROVED OUTLET.

NO SCALE

- 7.3 The actual subdrain locations will be evaluated in the field during the remedial grading operations. Additional drains may be necessary depending on the conditions observed and the requirements of the local regulatory agencies. Appropriate subdrain outlets should be evaluated prior to finalizing 40-scale grading plans.
- 7.4 *Rock fill or soil-rock fill* areas may require subdrains along their down-slope perimeters to mitigate the potential for buildup of water from construction or landscape irrigation. The subdrains should be at least 6-inch-diameter pipes encapsulated in gravel and filter fabric. *Rock fill* drains should be constructed using the same requirements as canyon subdrains.

7.5 Prior to outletting, the final 20-foot segment of a subdrain that will not be extended during future development should consist of non-perforated drainpipe. At the non-perforated/perforated interface, a seepage cutoff wall should be constructed on the downslope side of the pipe.

TYPICAL CUT OFF WALL DETAIL

FRONT VIEW

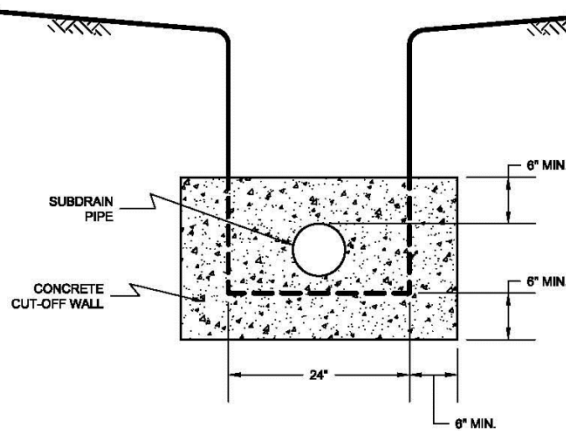

NO SCALE

SIDE VIEW

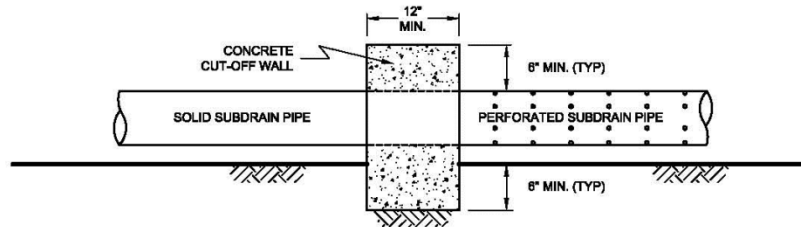

NO SCALE

7.6 Subdrains that discharge into a natural drainage course or open space area should be provided with a permanent headwall structure.

TYPICAL HEADWALL DETAIL

FRONT VIEW

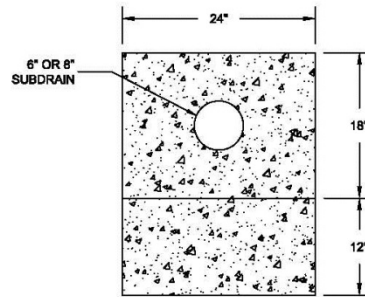

NO SCALE

SIDE VIEW

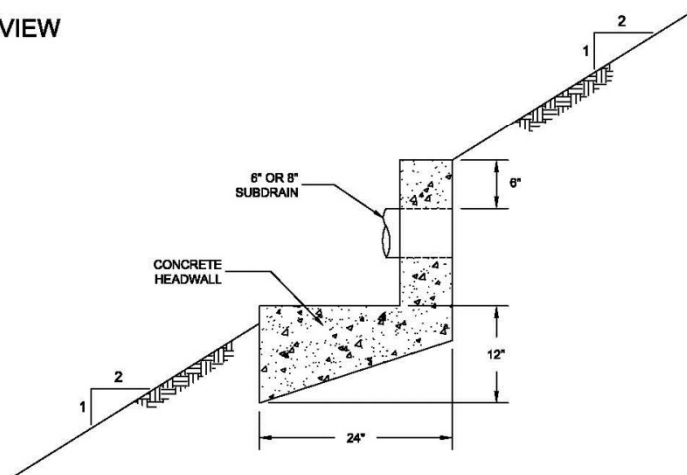

NOTE: HEADWALL SHOULD OUTLET AT TOE OF FILL SLOPE
OR INTO CONTROLLED SURFACE DRAINAGE

NO SCALE

- 7.7 The final grading plans should show the location of the proposed subdrains. After completion of remedial excavations and subdrain installation, the project civil engineer should survey the drain locations and prepare an “as-built” map showing the drain locations. The final outlet and connection locations should be determined during grading operations. Subdrains that will be extended on adjacent projects after grading can be placed on formational material and a vertical riser should be placed at the end of the subdrain. The grading contractor should consider videoing the subdrains shortly after burial to check proper installation and functionality. The contractor is responsible for the performance of the drains.

8. OBSERVATION AND TESTING

- 8.1 The Consultant shall be the Owner's representative to observe and perform tests during clearing, grubbing, filling, and compaction operations. In general, no more than 2 feet in vertical elevation of *soil* or *soil-rock* fill should be placed without at least one field density test being performed within that interval. In addition, a minimum of one field density test should be performed for every 2,000 cubic yards of *soil* or *soil-rock* fill placed and compacted.
- 8.2 The Consultant should perform a sufficient distribution of field density tests of the compacted *soil* or *soil-rock* fill to provide a basis for expressing an opinion whether the fill material is compacted as specified. Density tests shall be performed in the compacted materials below any disturbed surface. When these tests indicate that the density of any layer of fill or portion thereof is below that specified, the particular layer or areas represented by the test shall be reworked until the specified density has been achieved.
- 8.3 During placement of *rock* fill, the Consultant should observe that the minimum number of passes have been obtained per the criteria discussed in Section 6.3.3. The Consultant should request the excavation of observation pits and may perform plate bearing tests on the placed *rock* fills. The observation pits will be excavated to provide a basis for expressing an opinion as to whether the *rock* fill is properly seated and sufficient moisture has been applied to the material. When observations indicate that a layer of *rock* fill or any portion thereof is below that specified, the affected layer or area shall be reworked until the *rock* fill has been adequately seated and sufficient moisture applied.
- 8.4 A settlement monitoring program designed by the Consultant may be conducted in areas of *rock* fill placement. The specific design of the monitoring program shall be as recommended in the Conclusions and Recommendations section of the project Geotechnical Report or in the final report of testing and observation services performed during grading.
- 8.5 We should observe the placement of subdrains, to check that the drainage devices have been placed and constructed in substantial conformance with project specifications.
- 8.6 Testing procedures shall conform to the following Standards as appropriate:

8.6.1 Soil and Soil-Rock Fills:

- 8.6.1.1 Field Density Test, ASTM D 1556, *Density of Soil In-Place By the Sand-Cone Method.*

- 8.6.1.2 Field Density Test, Nuclear Method, ASTM D 6938, *Density of Soil and Soil-Aggregate In-Place by Nuclear Methods (Shallow Depth)*.
- 8.6.1.3 Laboratory Compaction Test, ASTM D 1557, *Moisture-Density Relations of Soils and Soil-Aggregate Mixtures Using 10-Pound Hammer and 18-Inch Drop*.
- 8.6.1.4 Expansion Index Test, ASTM D 4829, *Expansion Index Test*.

9. PROTECTION OF WORK

- 9.1 During construction, the Contractor shall properly grade all excavated surfaces to provide positive drainage and prevent ponding of water. Drainage of surface water shall be controlled to avoid damage to adjoining properties or to finished work on the site. The Contractor shall take remedial measures to prevent erosion of freshly graded areas until such time as permanent drainage and erosion control features have been installed. Areas subjected to erosion or sedimentation shall be properly prepared in accordance with the Specifications prior to placing additional fill or structures.
- 9.2 After completion of grading as observed and tested by the Consultant, no further excavation or filling shall be conducted except in conjunction with the services of the Consultant.

10. CERTIFICATIONS AND FINAL REPORTS

- 10.1 Upon completion of the work, Contractor shall furnish Owner a certification by the Civil Engineer stating that the lots and/or building pads are graded to within 0.1 foot vertically of elevations shown on the grading plan and that all tops and toes of slopes are within 0.5 foot horizontally of the positions shown on the grading plans. After installation of a section of subdrain, the project Civil Engineer should survey its location and prepare an *as-built* plan of the subdrain location. The project Civil Engineer should verify the proper outlet for the subdrains and the Contractor should ensure that the drain system is free of obstructions.
- 10.2 The Owner is responsible for furnishing a final as-graded soil and geologic report satisfactory to the appropriate governing or accepting agencies. The as-graded report should be prepared and signed by a California licensed Civil Engineer experienced in geotechnical engineering and by a California Certified Engineering Geologist, indicating that the geotechnical aspects of the grading were performed in substantial conformance with the Specifications or approved changes to the Specifications.