

SR-60/World Logistics Center Parkway



Preliminary Geotechnical Design Report

Riverside County, California

City of Moreno Valley

08-RIV-60-PM 20.0/22.0

EA 0M5900

November 2018





Leighton Consulting, Inc.
A LEIGHTON GROUP COMPANY

November 7, 2018

Project No. 10326.002

Michael Baker International
3536 Concourse Street, Suite 100
Ontario, California 91764

Attention: Mr. Brandon Reyes, PE

**Subject: Preliminary Geotechnical Design Report
Proposed SR-60 / World Logistics Center (WLC) Parkway Interchange
Improvements - EA 0M590, PN 0813000109 – PM 21.37
Bridge No. 56-0488, Moreno Valley, California**

This *Preliminary Geotechnical Design Report (PGDR)* is to summarize findings and recommendations in support of the *Project Approval and Environmental Document (PA&ED) Phase* of the project. This report presents relevant geotechnical, geological and seismic findings and foundation recommendations based on existing information and assumptions made regarding proposed design. Such recommendations will require verification during future phases of design including Plans, Specifications and Estimates (PS&E) phase.

This report has been prepared by Leighton Consulting Inc. under the direction of the following registered professionals:



Simon I. Saaid, GE 2641
Principal Engineer



Robert F. Riha, CEG 1921
Senior Principal Geologist



Distribution: (1) Addressee (PDF copy via email)

TABLE OF CONTENTS

<u>Section</u>	<u>Page</u>
1.0 EXECUTIVE SUMMARY	1
2.0 INTRODUCTION.....	2
2.1 PURPOSE AND SCOPE OF WORK	2
2.2 PROPOSED IMPROVEMENTS	3
2.3 SITE DESCRIPTION / EXISTING FACILITIES.....	3
3.0 PERTINENT REPORTS / INVESTIGATIONS	4
4.0 PROPOSED IMPROVEMENTS.....	5
5.0 PHYSICAL SETTINGS	6
5.1 CLIMATE	6
5.2 TOPOGRAPHY AND DRAINAGE	7
5.3 PRIOR LAND USE	7
5.4 MAN-MADE AND NATURAL FEATURES	7
6.0 GEOLOGY	8
6.1 REGIONAL	8
6.2 SITE.....	8
6.2.1 Fill.....	8
6.2.2 Alluvial Deposits.....	8
6.2.3 San Timoteo Formation.....	9
6.3 SOILS.....	9
6.4 FAULTING AND SEISMICITY	9
7.0 GEOTECHNICAL CONDITIONS	11
7.1 SUBSURFACE SOIL CONDITIONS	11
7.2 GROUNDWATER AND SURFACE WATER	11
7.2.1 Surface Water	11
7.2.2 Scour	11
7.2.3 Erosion.....	11
7.3 SECONDARY SEISMIC HAZARDS	12
7.4 SLOPE STABILITY	13
7.5 EXCAVATION CHARACTERISTICS.....	13
7.6 EMBANKMENTS	13
7.6.1 Embankment Foundations	13
7.6.2 Embankment Materials	13
7.7 VOLUMETRIC STABILITY OF EMBANKMENTS AND SUBGRADE MATERIALS	14
7.8 OTHER GEOLOGIC HAZARDS.....	14
7.8.1 Expansive Soils.....	14
7.8.2 Collapse Potential	14
8.0 HAZARDOUS WASTE POTENTIAL	15

9.0 PRELIMINARY RECOMMENDATIONS AND CONCLUSIONS	16
9.1 FUTURE EXPLORATION AND INVESTIGATIONS	16
9.1.1 Geotechnical Design Report(s):	16
9.1.2 Foundation Reports:.....	16
9.2 EMBANKMENTS	16
9.3 RETAINING WALLS.....	17
9.3.1 General.....	17
9.3.2 Retaining Wall Lateral Earth Pressures:.....	18
9.3.3 Retaining Wall Surcharges:.....	18
9.3.4 Retaining Wall Foundations:	19
9.4 SITE PREPARATION AND OVER-EXCAVATION	19
9.4.1 Approach Fill.....	20
9.4.2 Structure Approach Slab	20
9.5 RIPPABILITY	20
9.6 SHRINKAGE AND BULKING POTENTIAL	21
9.7 OTHER EARTHWORK CONSIDERATIONS.....	21
9.7.1 Import Soils.....	21
9.7.2 Trench Excavation and Backfill	21
9.8 CORROSION POTENTIAL.....	21
10.0 OTHER CONSIDERATIONS	23
10.1 TEMPORARY EXCAVATIONS AND SHORING.....	23
11.0 LIMITATIONS	24
REFERENCES.....	25

LIST OF TABLES

TABLE 1. WEATHER DATA	6
TABLE 2. USDA SOIL DATA.....	9
TABLE 3. LOCAL ACTIVE FAULTS.....	10
TABLE 4. LATERAL EARTH PRESSURES.....	18

Accompanying Figures and Appendices

Figure 1 – Site Vicinity Map	End of Text
Figure 2 – Regional Geologic Map	End of Text
Figure 3 – Regional Fault Map	End of Text
Figure 4 – Proposed Improvements/Previous Borings	End of Text

Appendix A – Existing Bridge LOTB and Previous Exploratory Borings Logs/Test Pits and Laboratory Test Results

Appendix B – Planning Study Sheet

1.0 EXECUTIVE SUMMARY

This *Preliminary Geotechnical Design Report (PGDR)* is provided in support of the *Project Approval and Environmental Document (PA&ED) Phase for the Proposed SR-60/ World Logistics Center (WLC) Parkway Interchange Improvements project*. Conclusions and recommendations presented herein are based on available as-built subsurface soil information from Caltrans-Log-of-Test-Borings (LOTBs) for existing bridge and other published and in-house geologic and geotechnical information for this area. Such recommendations will require verification during future phases of design including PS&E phase. Based on existing information, our main geotechnical findings and recommendations are as follows:

- **Active Surface Faulting:** Although the existing bridge is not located within currently designated Alquist-Priolo (AP) Earthquake Fault Zone, an un-named “fault splay” currently located outside the mapped AP Fault Zone is projected toward the bridge (see Figure 3). A separate study should be undertaken during the PS&E phase to evaluate this splay and determine whether potential fault rupture exists within the bridge footprint. As shown on Figure 3, portions of the NE and SE quadrants of the interchange are located within currently designated AP Fault Zone.
- **Remedial Grading/Over-Excavation:** Due to potentially compressible and/or collapsible soils within the onsite alluvium, the upper 5 to 8 feet of existing alluvium in the NW and SE quadrants should be removed/over-excavated and recompacted in preparation for the filling or pavement construction for the on-/off-ramps or any settlement sensitive structures. Actual depth of removals/over-excavation should be further evaluated based on field and laboratory testing during the PS&E phase.
- **Liquefaction:** Due to the depth of groundwater and the generally dense nature of alluvium on this site, liquefaction is not expected to be a constraint for the proposed improvements.
- **Bridge Foundations:** At this phase of project development, both driven pile and cast-in-drilled-hole (CIDH) pile may be considered for the proposed replacement bridge (Bridge No. 56-0488). However, it is recommended that new bridge is supported on similar foundations as existing bridge (CIDH piles).

2.0 INTRODUCTION

2.1 Purpose and Scope of Work

The City of Moreno Valley (City), in cooperation with the California Department of Transportation (Caltrans), District 8, proposes to reconstruct and improve the State Route 60 (SR-60)/WLC Parkway interchange. The majority of the project site is located in the City of Moreno Valley; however, the northeast quadrant of the site is located within unincorporated Riverside County (County) but within the City's Sphere of Influence. The purpose of the project is to alleviate existing and future traffic congestion at this interchange during peak hours, to improve traffic flow along the freeway and through the interchange, to improve safety by upgrading the geometry at the current interchange, and to provide standard vertical clearance for the overcrossing.

We understand that a segment of Theodore Street has been renamed to World Logistics Center (WLC) Parkway. As such, the SR-60/Theodore Street Interchange Project will now be referred to as the SR-60/WLC Parkway Interchange Project (Project) funded with local (Measure A) and federal funds. The Project will be required to comply with both the California Environmental Quality Act (CEQA) and the National Environmental Policy Act (NEPA). Caltrans will be the Lead Agency for CEQA, the City is a Responsible Agency under CEQA, and the Federal Highway Administration (FHWA) is the federal Lead Agency for NEPA.

The purpose of this PGDR is to provide preliminary geotechnical recommendations for the proposed improvements associated with the SR-60/World Logistics Center Parkway Interchange project. Our scope of work generally included research of existing information relevant to this project, a brief site reconnaissance, geotechnical analyses, and preparation of this report. We have relied primarily on available as-built Caltrans Log of Test Borings (LOTBs) for the existing bridge/overcrossing and published geotechnical and geologic data pertinent to this site including available in-house data. Reviewed documents are referenced at the end of this report. Separate *Preliminary Materials Report* (PMR) and *Structures Preliminary Geotechnical Report* (SPGR) are being prepared for this PA&ED Phase.

2.2 Proposed Improvements

We understand that three alternatives and two design variations will be evaluated in the environmental document for the Project: Alternative 1 (No Build Alternative [no project]), Alternative 2 (Modified Partial Cloverleaf), and Alternative 6 (Modified Partial Cloverleaf with Roundabout Intersections). The Design Variations for each Build Alternative are similar and would realign the Eucalyptus Avenue to join WLC Pkwy approximately 900 feet south of the existing Eucalyptus Avenue/WLC Pkwy intersection. The proposed project would construct modifications to the existing SR-60/WLC Pkwy interchange from Post Mile 20.0 to Post Mile 22.0 on SR-60, a distance of approximately 2 miles (mi). Major improvements to the interchange will include: (1) reconstruction of the westbound and eastbound on- and off-ramps to SR-60, and (2) replacement of the existing WLC Pkwy overcrossing with an expanded four-lane overcrossing (two through lanes in each direction) with a minimum 16.5-foot (ft) vertical clearance between the eastbound and westbound SR-60 ramps and reconstruction of WLC Pkwy between the southern limits of the project and the eastbound SR-60 ramps. Other improvements such as infiltration basins, lighting, landscaping, traffic signals and roadway-ramp re-striping are anticipated. The proposed improvements will impact the four quadrants of the interchange.

2.3 Site Description / Existing Facilities

The site of the proposed improvements is the existing SR-60/Theodore Street interchange located in the City of Moreno Valley, California (see *Site Vicinity Map - Figure 1*). The SR-60 freeway is aligned in an east-west direction and carries vehicular traffic through Moreno Valley and Riverside County. The existing interchange consists of two-quadrant cloverleaves with elongated loops in the northwest and southeast quadrants. The existing bridge/overcrossing (PM 21.37, Bridge No. 56-0488) is a four-span structure with concrete girders supported on CIDH piles. Embankment heights at both ends of the bridge vary up to 25 feet with side slopes at gradients up to 2:1 (Horizontal: Vertical). The existing bridge and ramps currently provide one lane in each direction. The existing on- and off-ramps have been recently widened and received an overlay as part of the off-site improvements for the adjacent industrial warehouse (Skechers). Any surface elevations given in this report are based on the current geodetic reference system (NAD 83).

3.0 PERTINENT REPORTS / INVESTIGATIONS

Leighton previously performed numerous geotechnical studies along portions of the proposed improvements as part of the off-site improvements associated with the adjacent industrial warehouse (Skechers) located southwest of the existing interchange. Pertinent documents/ reports reviewed are listed below (also referenced at the end of this report):

- Preliminary Geotechnical Evaluation (revised 2013) for Environmental Impact Report for “World Logistics Center Specific Plan” located south of SR-60 between Redlands Boulevard and Gilman Springs Road. This report provided a geologic/ geotechnical review of the overall site that includes most of the proposed alignment/widening associated with the new interchange.
- As-Graded Soils Report (2011) for “Highland Fairview Corporate Park, Parcels 1-4, Lots A-G, K and L of Parcel Map 35629”, located north of Eucalyptus Avenue and south of SR-60 west of Theodore Street. This report includes a description of the grading and compaction testing associated with the existing widening of SR-60 (south side) between Redlands Boulevard and Theodore Street including existing east bound on- and off-ramps.
- Geotechnical Evaluation (2010) for the “Proposed Domestic Water Pipeline Crossing Beneath State Route 60” at Sinclair Street Alignment. Report included a soils profile for the pipeline crossing beneath SR-60.
- Materials/Geotechnical Design Report (2010) for “SR-60 East and West Bound On-Ramp/Off Ramps to Theodore Street.” Report included a pavement evaluation including testing of subgrade soils for the purpose of designing new pavement sections and/or overlays.
- Pavement Evaluation (2008) for the “Proposed Street Improvements” associated with Theodore Street as part of the adjacent Highland Fairview Corporate Park. Report included a pavement evaluation including testing of subgrade soils for the purpose of designing new pavement sections and/or overlays.
- Preliminary Geotechnical Evaluation (2008) for the “SR-60 Widening between Theodore Street and Redlands Boulevard” (south side). Report included a geotechnical investigation and slope stability analysis for proposed slopes.

Extensive laboratory testing program was performed as part of the above studies, which included in-situ moisture content and density; grain-size distribution; R-value; Expansion Index; and Corrosivity testing including soluble sulfate contents, chloride, potential of hydrogen (pH), and resistivity. A summary of the test results is presented in subsequent sections of this report (Section 6.2).

4.0 PROPOSED IMPROVEMENTS

We understand that three alternatives and two design variations will be evaluated in the environmental document for the Project: Alternative 1 (No Build Alternative [no project]), Alternative 2 (Modified Partial Cloverleaf), and Alternative 6 (Modified Partial Cloverleaf with Roundabout Intersections). The Design Variations for each Build Alternative are similar and would realign the Eucalyptus Avenue to join WLC Pkwy approximately 900 feet south of the existing Eucalyptus Avenue/WLC Pkwy intersection. The proposed project would construct modifications to the existing SR-60/WLC Pkwy interchange from Post Mile 20.0 to Post Mile 22.0 on SR-60, a distance of approximately 2 miles (mi). Major improvements to the interchange will include: (1) reconstruction of the westbound and eastbound on- and off-ramps to SR-60, and (2) replacement of the existing WLC Pkwy overcrossing with an expanded four-lane overcrossing (two through lanes in each direction) with a minimum 16.5-foot (ft) vertical clearance between the eastbound and westbound SR-60 ramps and a six-lane cross-section on WLC Pkwy between the southern limits of the project and the eastbound SR-60 ramps. Other improvements such as infiltration basins, lighting, landscaping, traffic signals and roadway-ramp re-striping are anticipated.

5.0 PHYSICAL SETTINGS

5.1 Climate

The project area is located in an “Inland Valley” Climatic Region per Topic 615 of Caltrans Highway Design Manual (HDM). The hottest months are July, August, and September (Intellicast, 2018) when high temperatures average in the high 90’s (°F) and low temperatures average in the low 60’s (°F). The coolest temperatures occur in the winter months when the average highs are in the low 60’s and average lows are just above freezing (32°F). The extreme high temperatures range from about 85°F to as high as 115°F in July, August, and September. The extreme low temperatures range from approximately 30°F in December and January to the mid 50’s (°F) in the summer months. Freezing occurs occasionally during winter nights when the probability of freezing can be as high as 50 to 60 percent. Annual precipitation is in the 10 to 15-inch range, with most rain (about 80 percent) falling between November and March. This climate does not affect the design of the proposed improvements; however, it should affect the selection of asphalt binder grade. Table 1 below provides a monthly climatic record for this area (Intellicast, 2018).

TABLE 1. WEATHER DATA

Month	Average Low (°F)	Average High (°F)	Record Low (°F)	Record High (°F)	Average Precipitation (in)
January	42	66	24 (1963)	97 (2003)	2.47
February	44	68	27 (1962)	92 (2002)	2.39
March	45	70	29 (1962)	98 (2004)	2.19
April	48	76	33 (1956)	104 (1989)	0.60
May	53	80	38 (1965)	108 (1984)	0.25
June	57	87	44 (1999)	112 (1961)	0.10
July	61	94	49 (1966)	113 (1960)	0.03
August	62	94	49 (1978)	112 (1998)	0.17
September	60	91	42 (1970)	113 (1979)	0.26
October	53	83	32 (1971)	108 (1980)	0.26
November	45	74	26 (1958)	97 (2002)	0.78
December	41	68	22 (1990)	93 (1958)	1.17

5.2 Topography and Drainage

The overall site topography slopes gently in a southerly direction, except in the northeast quadrant where relatively steep slopes exist. Surface drainage from the surrounding areas north of SR-60 is collected within small localized channels/gullies and directed into several culverts crossing beneath SR-60 between Redlands Boulevard and existing Theodore Street. These culverts are all now connected to the recently improved Riverside Flood Control channel (Line F) located along the south side of SR-60. As of the date of this report, no new culverts are proposed to cross SR-60 as part of the proposed improvements. Based on USGS topographic maps, site elevations range from a high of approximately 1860 feet above mean sea level (msl) in the northeastern portion of the site to a low of approximately 1760 msl in the western portion of the site.

5.3 Prior Land Use

The majority of the site is currently occupied by the existing SR-60/WLC Parkway interchange improvements. The northwest quadrant appears to have been used for agricultural and farming purposes. The northeast quadrant is currently occupied by existing ramps and residential property/vineyards. The southeast quadrant (area of the proposed EB on-ramp) is a Metropolitan Water District (MWD) property. Based on existing information, a portion of this property was used as a staging area and soil stockpile during construction of the Inland Feeder Riverside Badlands Tunnel from October 1998 through July 2001 (Arabashi et al, 2003). A considerable stockpile of various soils and gravels/rock fragments is located between WLC Parkway and west of the existing northwest to southeast drainage located east of WLC Parkway. These materials are assumed to be spoils from the Inland Feeder tunnel and pipeline alignment construction. The majority of the embankment for WLC Parkway EB off-ramp in the southwest quadrant is already constructed as part of the off-site improvements for the adjacent "Skechers World Logistic Center" (Leighton, 2011). This embankment generally consists of engineered fill as further described in Section 7.4 of this report.

5.4 Man-Made and Natural Features

As indicated above, the majority of the embankment for WLC Parkway EB off-ramp in the southwest quadrant is already constructed. In addition, significant fill is noted as part of the existing bridge approaches (especially along the south side) and associated ramps. Relatively steep slopes exist in the northeast quadrant. Elsewhere, the site is relatively flat and will require minor cut and fill grading. Light to moderate vegetation should be expected in newly acquired areas for proposed ramps and slopes.

6.0 GEOLOGY

6.1 Regional

The site is located within the Peninsular Ranges Province, which is characterized by northwest trending elongated mountain ranges and valleys. The Peninsular Ranges Province is divided into 3 major fault bounded tectonic blocks within San Andreas Fault System, which consist of (from west to east): Santa Ana, Perris, and San Jacinto Blocks. The site is situated near the northeastern boundary of the relatively stable Perris Block.

More specifically, the site is located within the northern portion of the San Jacinto Valley, a fault-bounded tectonic basin that has evolved from movement along the San Jacinto fault system resulting in a down-dropped northwest-trending trough. The elongate transverse basin is believed to have formed as a result of a right step of the fault zone between the Casa Loma and Claremont strands of the fault zone (Morton and Matti, 1993).

6.2 Site

As mapped by the USGS (Morton, 2004), the natural geologic units within the site are very young to young alluvial fan deposits as well as Pleistocene-aged formational materials (north ramp), see the *Regional Geologic Map*, (Figure 2). In addition, fill materials comprised most of the existing improvements and recently constructed EB off-ramp. Based on existing information, these different soils units may be further described as follows:

6.2.1 Fill

Artificial fill including pavement materials is comprised of the existing bridge approaches and on- and off-ramps. Based on previous investigations (Leighton, 2010b) these materials are expected to consist of silty fine to coarse sand (SM) and sandy silt (ML) with Expansion Index (EI) less than 51 (low expansion). In addition, fill materials comprised most of the existing /recently constructed EB off-ramp. This fill was placed during the offsite improvements for the adjacent industrial warehouse (Skechers) located southwest of the existing interchange (Leighton, 2011)

6.2.2 Alluvial Deposits

The alluvial soils in this area were deposited as part of a complex depositional environment and generally include interbedded fine to coarse sands and silts with varying amounts of clay. The recent alluvial soils (younger alluvium) are found in drainages and believed to constitute the upper surficial materials (upper 3 to 10 feet).

The deeper materials (older alluvium and older fan-deposits) consist of silty fine sand to sandy silt with interbedded lenses of silty clay. The recent alluvial materials (upper 3 to 5 feet within on- and off-ramps alignment) generally consist of silty sand and sandy silt (SM/ML) with low expansion potential. Site specific field explorations will be performed during the PS&E phase to verify such conditions.

6.2.3 San Timoteo Formation

This Pleistocene-aged San Timoteo formation was encountered in one of our previous geotechnical borings along the north side of SR-60 and exposed in NE quadrant cut slopes. Based on our field observation and published data, this formation locally consists of poorly consolidated sands, silts, sandy gravel and gravel conglomerate.

6.3 Soils

Based on the results of our previous laboratory testing, the soil properties determined per United States Department of Agriculture National Resources Conservation Services (USDA, 2018) are included in the Table below:

TABLE 2. USDA SOIL DATA

Soil Properties	Value/Unit
Map Soil Unit – Majority of site	SeC2 – San Emigdio fine sandy loam
Soil Erodibility Factor	0.20 – 0.4
Hydrologic Soil Group	A
Depth to any Restrictive Layer (cm)	>200

Based on previous testing performed for adjacent site (Leighton, 2011), the range of infiltration rates for surficial soils is expected to range from 0.1 to 0.5 inch-per-hour and the soil erodibility (K) factor per USDA nomograph is expected to generally vary from 0.2 to 0.4.

6.4 Faulting and Seismicity

The subject site, like the rest of Southern California, is located within a seismically active region as a result of being located near the active margin between the North American and Pacific tectonic plates. The principal source of seismic activity is movement along the northwest-trending regional fault systems such as the San Andreas, San Jacinto, and Elsinore Fault Zones. Currently, these fault systems accommodate up to approximately 55 millimeters per year (mm/yr) of slip between the plates. The onsite San Jacinto Fault Zone is estimated to accommodate slip of approximately 12 mm/yr (WGCEP, 1995).

Historically, the San Jacinto fault zone has produced earthquakes in the magnitude range of 6.2Mw to 7.2Mw ('Mw' is the Moment Magnitude as defined by the USGS). Of all the fault systems in California, the San Jacinto Fault and San Andreas Fault are among the most active. A list of major local faults and their seismic characteristics is presented in table below.

TABLE 3. LOCAL ACTIVE FAULTS

Fault Name	Fault Type	Maximum Moment Magnitude (MMax)	Peak Ground Acceleration (g)	Distance from Site (km)
San Jacinto (San Jacinto Valley)	SS	7.7	0.51	0.31
San Jacinto (San Bernardino Valley)	SS	7.7	0.42	4.62
San Jacinto (Anza)	SS	7.7	0.39	6.31

As shown on Figure 3, a portion of the site is located within the Claremont Segment of the San Jacinto Fault Zone. In addition, an unnamed fault splay is projected to transect the proposed bridge (see Figure 3). A fault trench investigation should be performed as part of the bridge foundation report during the PS&E phase to confirm the existence or absence of this fault splay. Based on *Caltrans Seismic Design Criteria* (Caltrans, 2013b), the peak ground acceleration expected at the site is 0.86g and the probabilistic analysis is the controlling spectrum for this bridge. The analysis was performed using a soil profile type D and an average shear wave velocity of 270 m/s based on SPT N-value correlation from existing bridge LOTBs and our previous studies in the immediate vicinity of this site (Leighton, 2010 and 2011).

7.0 GEOTECHNICAL CONDITIONS

7.1 Subsurface Soil Conditions

Based on previously performed field investigations (Leighton, 2010 & 2011) and LOTB's for the existing overcrossing, the site is generally underlain by silty sand (SM). Based on previous borings in this area (Leighton, 2008 & 2010), the encountered soils were loose to medium dense with N-values ranging from 5 to 22 for shallow soils and increasing up to 50 for deeper soil (based on existing LOTB's). Site specific field explorations will be performed during the PS&E phase to verify such conditions.

7.2 Groundwater and Surface Water

According to the Riverside County General Plan Safety Element (Riverside, 2003), depths of groundwater at this site are reported to be in excess of 110 feet below existing ground surface (Elevation 1665 feet). There are no significant excavations proposed as part of the subject project surrounding as the primary improvements consist of fill placement; therefore, the presence of groundwater is not anticipated to have any adverse constructability impacts.

7.2.1 Surface Water

Standing surface water was not observed in the project area during our recent site visit. Existing drainage facilities such as natural channels, v-ditches and box culverts provide routes for surface water to drain away from the project area.

7.2.2 Scour

This overall site is relatively flat with existing drainage structures preventing uncontrolled storm runoff from entering the project area. Therefore, scour is not considered a design issue for the proposed improvements.

7.2.3 Erosion

Onsite soils (silt and sands or fine sandy loam per USDA) are inherently subject to erosion, particularly if exposed to rainfall and irrigation. Unpaved sloping grades that are susceptible to erosion within the project limits include the approach embankments and potentially cut slopes in the northeast quadrant. Erosion of the existing slope faces was observed to be minimal. However, provisions for site drainage, slope planting and other measures in accordance with Caltrans requirements should be fulfilled to provide adequate protection against short- and long-term erosion.

7.3 Secondary Seismic Hazards

Secondary hazards generally associated with severe ground shaking during an earthquake are ground rupture, tsunamis and seiches, landslides, rockfalls, ground fissuring, liquefaction, and seismic densification. These hazards are discussed below:

- *Seismic Densification:* Ground accelerations generated from a seismic event can produce settlements in dry or moist sands (granular earth materials) with relative low density. We anticipate that the near-surface loose soil deposits susceptible to such seismically induced settlement will be generally removed and recompacted during grading. As such, the potential total seismic densification is anticipated to be global and less than 2 inches for surface structures. However, additional evaluation of seismic densification based on actual field data for proposed structures should be performed in future phases of project development.
- *Liquefaction Settlement:* Due to deep groundwater, relatively dense alluvial soils, and interbedded clay layers underlying the site, it is our opinion that potential for liquefaction at the subject site is very low and not a design issue.
- *Tsunamis and Seiches:* Due to the distance to large bodies of water (inland seas, large rivers, and oceans) from the site, the possibility of tsunamis is considered non-existent. A seiche is a temporary disturbance or oscillation in the water level of a lake or partially enclosed body of water, especially one caused by changes in atmospheric pressure. The ephemeral Mystic Lake located approximately four miles southeast of the project and Perris Reservoir located approximately 4½ miles south of the site are lower in elevation. As such, the potential for seiches from these two enclosed body of water to affect this site is considered unlikely.
- *Rock Falls:* The potential for rock fall due to either erosion or seismic ground shaking is considered very low or non-existent on this site.
- *Ground Rupture:* As shown on Figure 3, some of the proposed improvements (i.e. on- and off-ramps) are located within the Claremont Segment of the San Jacinto Fault Zone. In addition, an unnamed fault splay is projected to transect the existing/proposed bridge. As such, a ground rupture can occur along any of these active faults in case of seismic activity. A fault trench investigation will be performed for the bridge structure to confirm the existence or absence of any fault. The results will be submitted under a separate cover.

7.4 Slope Stability

Although no cut slopes are proposed at this time, 2:1 (H:V) cut slopes in the alluvium are considered globally stable to a maximum depth of 20 feet based on past experience with onsite soils (Leighton, 2008d). Any temporary excavations, including temporary shoring, necessary to construct any retaining walls/footings or culverts will need to be designed by the contractor for surficial and deep-seated stability, once the means and methods of construction are determined.

7.5 Excavation Characteristics

Based on the results of our previous investigations in the vicinity of this project site, the onsite fill, alluvium and bedrock should generally be excavatable with conventional earthmoving equipment. As such, the near-surface materials are not expected to pose a rippability problem. Oversized materials (i.e. greater than 6 inches) might be generated in deep cuts in the northeast quadrant, if any.

7.6 Embankments

The existing approach embankments at WLC Parkway bridge are composed of fill material and vary up to 25 feet in height with graded side slopes varying from 2:1 (H:V) to shallower than 4:1 (H:V). These embankments are expected to be partially or totally removed as part of the new bridge design/alignment.

7.6.1 Embankment Foundations

For planning purposes, we anticipate over-excavation of the upper 3 to 5 feet of alluvium beneath all new bridge approaches. Deeper over-excavation (5 to 8 feet) should be expected for the on-/off ramp embankments. However, no over-excavation should be required for the EB off-ramp, which was mostly constructed as part of the adjacent Skechers (Leighton, 2011). Future site-specific investigations will further delineate the extent of the compressible alluvium and/or required depth of over-excavation for all proposed embankments.

7.6.2 Embankment Materials

Based on previous investigations in this area, the surficial soils generally consist of silty fine to coarse sand and sandy silt. These materials are generally suitable for reuse as compacted fill, provided they are free of organic materials, debris and oversize materials and comply with Caltrans embankment fill requirements. The onsite surficial soils include undocumented fill associated with the existing ramps.

7.7 Volumetric Stability of Embankments and Subgrade Materials

Based on our experience with onsite soil types, 2:1 (H:V) fill slopes for embankment construction are considered stable with respect to deep-seated failure. For new construction, widening or where slopes are otherwise being modified, embankment fill should be 4:1 or flatter per Topic 304.1 of the HDM.

7.8 Other Geologic Hazards

Other geologic hazards that might be encountered or will need further evaluation during future investigation include the following:

7.8.1 Expansive Soils

The results of our previous laboratory testing on representative samples collected from various areas within this site and adjacent sites indicate the presence of potentially expansive soils ($0 < EI < 91$). However, the majority of the site materials are expected to have an EI of less than 51. The more expansive soils ($EI > 51$) are expected to be localized and associated with interbedded silt and clay layers likely to be located in the south side of the bridge along WLC Parkway. These materials should not be used in embankment fills or upper 4 feet of pavement subgrade.

7.8.2 Collapse Potential

Based on our previous laboratory testing on representative samples collected from areas adjacent to this site, potentially collapsible soils (ASTM D 4546) may be present in the shallow alluvium. This collapse potential should be further evaluated during future investigations to determine the required depth of over-excavation.

8.0 HAZARDOUS WASTE POTENTIAL

An Aerially-Deposited Lead (ADL) study was previously conducted by Leighton for the widening of the south side of SR-60 between Redlands Boulevard and WLC Parkway. Based on the results of the study, it was found that ADL impacted soils do not exist at hazardous levels within the limits of the studied area. However, another ADL study will be performed by Leighton for areas not previously investigated and the results will be submitted under a separate cover. In addition, the WLC Parkway overcrossing will be sampled and tested for asbestos containing materials and lead. If found, any ADL impacted soils or any affected lead-based paint/pavement markings should be collected, tested, and transported/disposed of, in accordance with applicable State and federal regulations.

Based on the results of Initial Site Assessment (ISA) recently performed by Leighton for this project to identify recognized environmental conditions (RECs) in connection with the Project, some potential right-of-way properties acquired will be tested for residual organochlorine pesticides (OCPs) and arsenical herbicides in the subsurface soil in accordance with the approved work plan.

9.0 PRELIMINARY RECOMMENDATIONS AND CONCLUSIONS

9.1 Future Exploration and Investigations

As part of the next phase of project development (PS&E), final reports should be prepared to verify the preliminary recommendations included herein. These reports include:

9.1.1 Geotechnical Design Report(s):

Grading plans have not been developed at this time, so detailed slope stability analyses could not be performed. Geotechnical exploration, testing and evaluation will have to be established based on proposed grading and alignment schemes. This should include slope stability evaluations, particularly for any proposed cuts and fills. Borings and infiltration tests will also be required at new stormwater infiltration basins.

9.1.2 Foundation Reports:

Caltrans requires a foundation report specific to each new or widened bridge, non-standard retaining walls and non-standard signs. More specifically, geotechnical explorations will be required for the following:

- Bridges: A boring at each bridge abutment and bent (or two borings at each for bridges wider than 100 feet),
- Retaining Walls: A boring every 250 feet of retaining wall, sometimes two rows of borings for walls,
- Sound Walls: A boring every 500 feet of sound wall,
- Stormwater Conduits: Borings are typically performed at 250-feet along the conduit (for larger conduits), and
- Overhead Signs: A boring is typically performed at each overhead sign.

9.2 Embankments

Based on past experience with onsite soils (Leighton, 2008d), graded slopes along the alignment no-steeper-than 2:1 are generally expected to be stable under static and dynamic conditions. However, some surficial instability should be anticipated if slopes are not properly protected against erosion.

Where right-of-way allows, embankment side slopes should be constructed at an inclination no steeper than 4:1 in accordance with Caltrans design requirements. However, in areas where space is constrained by limited right of way or other physical constraints, stable slopes are expected to be feasible from a geotechnical perspective

with inclinations up to 2:1. Stability of embankment slopes will be addressed in the final Geotechnical Design Report (GDR), based on actual proposed grading concepts and plans.

The onsite soils (SM/ML materials) are anticipated to be generally suitable for reuse as compacted fill, provided they are free of organic materials, debris and oversize materials (greater than 3 inches in greatest dimension). The optimum lift thickness to produce a uniformly compacted fill will depend on the type and size of compaction equipment used. In general, fill should be placed in uniform lifts not exceeding 8 inches in thickness.

Any imported materials placed within the upper 4 feet of finished grade within paving areas should have a minimum R-value of 40 and should be non-corrosive and of low expansion. Other construction materials such as aggregates, asphalt, and Portland cement should be imported from local commercial sources. Potential sources for import materials are being considered for this project. Therefore, prior to import, the materials should be tested and approved by the Geotechnical Engineer and the District Materials Engineer.

Cut slopes excavated at 2:1 (H:V) in the northeast quadrant are anticipated to be generally grossly stable and have calculated factors of safety of at least 1.5 under static conditions and 1.1 for seismic conditions for a maximum height of 30 feet. However, the cut slopes should be analyzed in greater detail utilizing site specific data during final Geotechnical Design Report. Additional slope stability evaluation should be performed when development plans become available.

In addition, slope faces are inherently subject to erosion, particularly if exposed to rainfall or irrigation. Landscaping and slope maintenance should be conducted as soon as possible in order to increase long-term surficial stability

9.3 Retaining Walls

9.3.1 General

Caltrans Standard Retaining Wall (Type 1 or 5) cannot be used on this project site since the peak ground acceleration at this site is over 0.6g. The following are the preliminary geotechnical parameters to be used for design of retaining walls based on an ultimate shear strength friction-angle of 32 degrees:

TABLE 4. LATERAL EARTH PRESSURES

Drained Earth Pressure Conditions	Static Equivalent Fluid Pressure (pounds-per-cubic-foot)	
	Level Backfill	2:1 (horizontal:vertical) Sloped Backfill
Active (cantilever)	36	55
At-Rest (braced)	55	75
Passive	250 (allowable) (Maximum of 4,000 psf)	95 (allowable downslope direction)

9.3.2 Retaining Wall Lateral Earth Pressures:

Cantilever walls that are designed to yield at least $0.001H$, where H is equal to the wall height, may be designed using active earth pressures. Rigid walls and walls braced at the top should be designed using at-rest earth pressures. Passive pressure is used to compute soil resistance to lateral structural movement. In addition, for sliding resistance, a frictional resistance coefficient of 0.40 may be used at the concrete and soil interface for concrete poured/cast on undisturbed native sands and properly compacted Caltrans Structure Backfill. Lateral passive resistance should be taken into account only if it is ensured that soil providing passive resistance, embedded against shallow foundation elements, will remain intact with time (not erodible). These above values have already been reduced by a factor-of-safety of 1.5.

9.3.3 Retaining Wall Surcharges:

In addition to the above lateral earth forces, surcharge due to improvements, such as an adjacent structure, and/or traffic loading should be considered in design of retaining walls. Loads applied within a 1:1 (horizontal:vertical) projection down from the surcharging structure on the stem of the wall should be considered in wall design. A third of uniform vertical surcharge-loads should be applied as a horizontal pressure on cantilever (active) retaining walls, while half of uniform vertical surcharge-loads should be applied as a horizontal pressure on braced (at-rest) retaining walls. For sliding and overturning analyses, soil unit weight of 120 pounds-per-cubic-foot (pcf) may be assumed for calculating density of properly compacted fill soil over wall footings.

At the discretion of the project Structural Engineer (SE), incremental seismic earth pressures of $24H$ pounds-per-cubic-foot (pcf), where H is the retaining wall stem height in feet, may be used in addition to earth and surcharge pressure presented above. Traditionally, this incremental seismic earth pressure has been applied as an inverted triangle (inverted equivalent fluid pressure), with the largest earth pressure occurring at the top of the wall. Resultant seismic earth pressure force has traditionally been applied at approximately $0.5H$ from the bottom of the wall, where H is the wall (stem) height. However, based on recent studies (Sitar, et. al.) we suggest a uniform pressure distribution to be applied ($12H$ applied as a uniform/rectangular

pressure distribution) based on current research and observations and in general compliance with AASHTO LRFD 2012 procedures.

9.3.4 Retaining Wall Foundations:

For retaining walls up to 16 feet tall, founded on dense alluvium or Caltrans Structure Backfill, footings should have a minimum width of 36 inches and a minimum embedment of 18 inches below the lowest adjacent grade. A conceptual/preliminary allowable bearing capacity of 2,000 pounds-per-square-foot (psf) may be used for retaining wall footing design, based on these minimum footing dimensions. This bearing value may be increased by 250 psf per foot increase in footing width or depth to a maximum allowable bearing pressure of 3,000 psf.

No walls should be supported on a combination of shallow and deep foundations. Walls supported on shallow foundations should be structurally separated from any wall supported on deep foundations, to mitigate anticipated differential settlement of shallow spread footings relative to piles.

9.4 **Site Preparation and Over-Excavation**

Prior to earthwork, the areas that need to be cut, receive fill, or receive stockpile materials, should be cleared and stripped of all debris, deleterious materials, organics, and vegetation. Cleared and grubbed material and rubble waste that may be encountered or created, should be removed and appropriately disposed of, in accordance with Sections 17 and 19 of the latest version of Caltrans Standard Specifications. The upper six to twelve inches of site soils may be stockpiled and replaced on final grade to provide organic medium for future planting and enhance future vegetative erosion control. After clearing and grubbing, a minimum overexcavation of 3 feet should be accomplished within all areas to receive compacted fill. The overexcavation should extend horizontally a minimum distance of 3 feet from edges of new fills. Deeper excavations may be required in areas that are yet to be investigated and have not received any previous fills. Excavation bottoms should be observed to be firm and unyielding prior to fill placement. Remedial overexcavation should be performed at proposed culvert locations. The existing soils below the culvert footing should be overexcavated to a minimum depth of 2 feet below the footing bottom and recompacted to at least 95% relative compaction. The lateral extent of the overexcavation should be at least 2 foot beyond the edges of the culvert footing. Overexcavated soils can be used as backfill; the backfill should be compacted to at least 95% relative compaction (and/or Sections 19-5 and 19-6 of the latest version of Caltrans Standard Specifications).

9.4.1 Approach Fill

Imported material (if any) within the upper 4 feet of roadway finished grade should have low expansion potential, a minimum R-value of 40 and should be non-corrosive. Class 3 aggregate subbase can be used for the imported material within the upper 4 feet of finished grade.

The abutments should be backfilled in accordance with Sections 19-5.03B and 19-5.03C of Caltrans *Standard Specifications*. Abutments should consist of material free of organic material and construction debris, with SE greater than 20, and grading requirements as presented in Section 19 of *Standard Specifications*

The slopes of the existing embankments should be benched into a minimum of 6 feet horizontally as the new fill is brought up in layers. Excavated material should be recompacted along with the new embankment material. All materials and placement should conform to Sections 19-6 and 19-7 of *Standard Specifications*.

Based on previous borings in the vicinity, the subsurface soils consisted of sandy materials. Due to the nature of sandy soils, immediate settlement is expected to occur during or within a short period after placement of the embankment/approach fill and expected to be less than 1 inch.

9.4.2 Structure Approach Slab

Structure approach slab provides a smooth transition between roadway pavement and bridge structure. Design of the structure approach slab should be in accordance with *Memo to Designer 5-3* (Caltrans, 1992). Structure approach slab should extend the full width of the roadway including shoulder and, per *Highway Design Manual* (Caltrans, 2017). If applicable, it is recommended that dowel bars be placed at the transverse joint between the structure approach slab and new rigid pavement to ensure load transfer at the joint.

9.5 Rippability

Hardest rock along the alignment is the sedimentary San Timoteo Formation, encountered in one of our previous borings on the north side of SR-60. This formation consists of poorly consolidated sands, silts, sandy gravel, and gravel conglomerate and is expected to be predominantly rippable. However unlikely, some areas of moderately to non-rippable rock cannot be ruled out at this stage of the project. Additionally, grading in this formation may generate oversize material requiring special handling.

9.6 Shrinkage and Bulking Potential

The volume change of excavated onsite materials upon re-compaction is expected to vary with materials, density, insitu moisture content, location and compaction effort. The in-place and compacted densities of soil materials vary and accurate overall determination of shrinkage is difficult to estimate.

Although accurate grading factors cannot be determined at this time, the following estimates are provided for determining preliminary earthwork quantities.

<u>Material Type</u>	<u>Expected Volume Change after Compaction</u>
Existing Fill/Embankment	-5 percent to 15 percent
Alluvium	10 percent to 20 percent shrinkage

9.7 Other Earthwork Considerations

9.7.1 Import Soils

Import soil should be granular in nature, relatively free of organic material, and have an expansion index less than 51 (per ASTM Test Method D4829) and low corrosion impact to the proposed improvements. Project construction may involve the import of soils to the project site from a Mandatory Borrow Site. One borrow site, the City Stockpile, is located at the northwest corner of the intersection of Alessandro Boulevard and Nason Street in the City of Moreno Valley. This stockpile has been environmentally cleared by Earth Mechanics, Inc., (Earth Mechanics, 2012). Additional fill material beyond what is available at the City Stockpile will be necessary and will come from a site to be determined during future phases of the project. Import soils are to be obtained from a site listed on the most current and latest "AB3098 List", refer to Section 111.2(2) in Caltrans HDM.

9.7.2 Trench Excavation and Backfill

Utility trenches should be backfilled with compacted fill in accordance with the project specifications. Fill material should be placed in lifts not exceeding 8 inches in uncompacted thickness and should be compacted to at least 90 percent relative compaction. The upper 6 inches of backfill in all pavement areas should be compacted to at least 95 percent relative compaction. Trench backfill within 150 feet of each bridge abutment should be compacted to at least 95 percent relative compaction in accordance with the *Standard Specifications*.

9.8 Corrosion Potential

Representative soil samples should be tested for pH, sulfate content, chloride content, and minimum electrical resistivity as part of the final Foundation Report investigation for

this site. Caltrans *Corrosion Guidelines* (Caltrans, 2018) state that a site is considered to be corrosive to foundation elements or underground structures if one or more of the following conditions exist for the soil and/or water samples taken at the site:

- Chloride concentration greater than or equal to 500 ppm
- Sulfate concentration greater than or equal to 1,500 ppm
- pH of 5.5 or less

We anticipate that reinforced concrete pipes (RCP) might be used to extend existing culverts or install new culverts. Corrosive properties are not visually distinguishable characteristics. Based on previous soil testing performed in the immediate vicinity of this project, we anticipate the site soils to be non-corrosive.

10.0 OTHER CONSIDERATIONS

10.1 Temporary Excavations and Shoring

Excavations associated with construction may need shoring. Excavations during construction should be carried out in such a manner that failure and excessive ground movement do not occur. In general, unsupported slopes for temporary construction greater than 5 feet in height should be limited to a gradient of 1:1 (vertical to horizontal), or as field conditions dictate to provide a safe and stable slope. Surcharge loads from vehicles and stockpiled material should be kept away from the top of temporary excavations with a distance equal to at least one half of the excavation depth. Surface drainage should be controlled along the top of the temporary excavations to prevent excessive wetting and erosion of excavation faces. Where there is insufficient space for open excavations, shoring should be used to support the excavation.

All temporary excavations, including utility trenches, retaining wall excavations and other excavations should be performed in accordance with project plans, specifications, all OSHA and Cal-OSHA requirements, and the current edition of the California Construction Safety Orders (see: <http://www.dir.ca.gov/title8/sb4a6.html>). Contractors should be advised that sandy soils (such as fills generated from onsite alluvium) will primarily be encountered along the alignment, with sections of San Timoteo Formation. Fill and cohesionless alluvium should be classified as Type C soils.

The contractor must be responsible for providing a "competent person" as defined in Article 6 of the California Construction Safety Orders. During construction, exposed soil conditions should be regularly evaluated to verify that conditions are as anticipated. Close coordination between their competent person and the geotechnical engineer of record should be maintained to facilitate construction while providing safe excavations.

11.0 LIMITATIONS

This report was necessarily based in part upon data obtained from a limited number of observances, site visits, soil samples, tests, analyses, histories of occurrences, spaced subsurface explorations and limited information on historical events and observations. Such information is necessarily incomplete. The nature of many sites is such that differing characteristics can be experienced within small distances and under various climatic conditions. Changes in subsurface conditions can and do occur over time. This investigation was performed with the understanding that the subject site is proposed for residential and commercial development.

This report was prepared for Michael Baker International based on their needs, directions, and requirements at the time of our investigation. This report is not authorized for use by, and is not to be relied upon by any party except Michael Baker International, and its successors and assigns as owner of the property, with whom Leighton has contracted for the work. Use of or reliance on this report by any other party is at that party's risk. Unauthorized use of or reliance on this report constitutes an agreement to defend and indemnify Leighton from and against any liability which may arise as a result of such use or reliance, regardless of any fault, negligence, or strict liability of Leighton.

REFERENCES

- Arabashi, Jay; Steve Klein, John Waggoner, John Townsend, 2003, Riverside Badlands Tunnel, Inland Feeder Project: The Challenge between Concept and Completion.
- Bryant, W.A., and Hart, E.W., 2007, Fault-Rupture Hazard Zones in California, Alquist-Priolo Earthquake Fault Zoning Act with Index to Earthquake Zones Maps, Department of Conservation, California Geological Survey, Special Publication 42. 2007 Interim Revision.
- California Geological Survey, 2018, Earthquake Fault Zones, A Guide for Government Agencies, Property Owners/Developers, and Geoscience Practitioners for Assessing Fault Rupture Hazards in California, Special Publication 42, Revised 2018.
- California, Code of Regulations, 2018, Division of Industrial Safety, Title 8, Subchapter 4, Construction Safety Orders, <https://www.dir.ca.gov/title8/sub4.html>
- Caltrans, 2012, Bridge Inspection Report, Structure Maintenance and Investigations for Bridge Number 56 0488, Location 08-RIV-060-21.37, Dated January 11.
- Caltrans, 2013a, District Preliminary Geotechnical Reports, Division of Engineering Services - Geotechnical Services, dated May.
- Caltrans, 2013b, *Seismic Design Criteria*, Version 1.7, April.
<http://www.dot.ca.gov/hq/esc/techpubs/manual/othermanual/other-engineering-manual/seismic-design-criteria/sdc.html>
- Caltrans Standard Specifications Latest Version.
- Caltrans, June 2017a, *Foundation Reports for Earth Retaining Systems (ERS)*,
http://www.dot.ca.gov/hq/esc/geotech/geo_manual/page/FR_ERS_June2017.pdf
- Caltrans, 2017b, *Highway Design Manual (HDM)*, November 20.
- Caltrans, 2018a, *Corrosion Guidelines*, Version 3.0, March, 2018.
- Caltrans, 2018b, *ARS Online*, Version v2.3.09, April 27,
http://dap3.dot.ca.gov/ARS_Online/http://dap3.dot.ca.gov/ARS_Online/website_updates.php
- Earth Mechanics, Inc., 2012, Supplemental Nason Street/Alessandro Boulevard Stockpile Investigation, City of Moreno Valley, California, EMI Project No. 05-140, dated January 16, 2012.
- Geotracker <http://geotracker.waterboards.ca.gov/>

- Intellicast, 2018, Historic Average Temperature/Precipitation: www.intellicast.com,
- Jennings, C.W., and Bryant, W.A., 2010 Fault activity map of California: California Geological Survey, Geologic Data Map Series No. 6, map scale 1:750,000.
- Leighton and Associates, Inc., 2008a, Update Preliminary Geotechnical Report, Tentative Parcel Map 35629, Highland Fairview Corporate Park, City of Moreno Valley, California, Project No. 111061-116, dated April 30.
- Leighton and Associates, Inc., 2008b, Response to Screencheck Draft Environmental Impact Report Review Comments with Respect to Seismic/Faulting, Highland Fairview Corporate Park, Tentative Parcel Map 35629, Moreno Valley, California, Project No. 111061-116, dated June 4.
- Leighton and Associates, Inc., 2008c, Update Geotechnical Report, Moreno Highlands Specific Plan Area, Southeast Corner of Highway 60 and Redlands Boulevard, City of Moreno Valley, California, Project No. 111061-113, dated July 21.
- Leighton and Associates, Inc., 2008d, Preliminary Geotechnical Evaluation, SR-60 Widening between Theodore Street and Redlands Boulevard, Moreno Valley, Riverside County, California Project No. 111061-114, dated July 30, 2008.
- Leighton and Associates, Inc., 2008e, Pavement Evaluation, Proposed Street Improvements, Theodore Street, Highland Fairview Corporate Park, City of Moreno Valley, California. Project No. 111061-117, dated August 29.
- Leighton and Associates, Inc., 2010a, Preliminary Pavement Design, SR-60 East Bound and West Bound On-Ramp/Off Ramps to Theodore Street, Moreno Valley, California. Project No. 111061-123, dated April 2.
- Leighton and Associates, Inc., 2010b, Materials/Geotechnical Design Report, SR-60 East and West Bound On-Ramp/Off Ramps to Theodore Street, Moreno Valley, California. Project No. 111061-123, dated May 28.
- Leighton and Associates, Inc., 2010c, Geotechnical Evaluation, Proposed Domestic Water Pipeline Crossing Beneath State Route 60, Highland Fairview Corporate Park, Sinclair Street Alignment, Moreno Valley, California, dated September 16.
- Leighton and Associates, Inc. 2011a, As-Graded Soils Report, Highland Fairview Corporate Park, Parcels 1-4, Lots A-G, K and L of Parcel Map 35629, Eucalyptus Avenue, Moreno Valley, California, project No. 111061-201, dated July 8.

- Leighton and Associates, Inc. 2011b, Preliminary Geotechnical Evaluation for Environmental Impact Report, "The Highlands Specific Plan," South of Highway 60 between Redlands Boulevard and Gilman Springs Road, City of Moreno Valley, California, project No. 111061-126, dated December 13.
- Leighton Consulting, Inc. 2015, Structures Preliminary Geotechnical Report (SPGR), Proposed SR-60/Theodore Street Interchange Improvements, EA 0M590, PN 0813000109 – PM 21.37, Bridge No. 56-0488, Moreno Valley, California, dated March 23.
- Leighton Consulting, Inc. 2015, Draft Preliminary Materials Report (PMR), Proposed SR-60/Theodore Street Interchange Improvements, EA 0M590, PN 0813000109 – PM 21.37, Bridge No. 56-0488, Moreno Valley, California, dated June 5.
- Leighton Consulting, Inc. 2015, Draft Aerially Deposited Lead and Preliminary Site Investigation Workplan, Proposed SR-60/Theodore Street Interchange Improvements, EA 0M590, 08-RIV-60-PM 20.0/22.0, dated November.
- Morton, D.M., and Matti, J.C., 1993, Extension and contraction within an evolving divergent strike-slip fault complex: the San Andreas and San Jacinto fault zones at their convergence in southern California, in Powell, R.E., Weldon, R.J.II, and Matti, J.C., editors, The San Andreas fault system: displacement, palinspastic reconstruction, and geologic evolution: GSA, Memoir 178, p. 217-230.
- Morton, D.M., 2001, Geologic map of the Sunnymead 7 1/2-minute Quadrangle, Riverside County, California: U.S. Geological Survey Open-File Report 01-450, map scale 1:24,000. www.usgs.gov
- Morton, D.M., 2004, Preliminary Digital Geologic Map of the Santa Ana 30' X 60' Quadrangle, Southern California, Ver. 2.0, USGS Open-File Rep. 99-172, scale 1:100,000.
- Riverside County, 2018, Map My County, Riverside County Integrated Project Website, https://gis.countyofriverside.us/Html5Viewer/?viewer=MMC_Public
- USDA, 2015, Natural Resources Conservation Services, Web-based program, February
- WGCEP - Working Group on California Earthquake Probabilities, 1995, Seismic Hazards in Southern California: Probable Earthquake Probabilities, Bull. Seismol. Soc. Amer., Vol. 85, No. 2, pp 379-439.
- www.intellicast.com, 2018, Historic Average Temperature/Precipitation

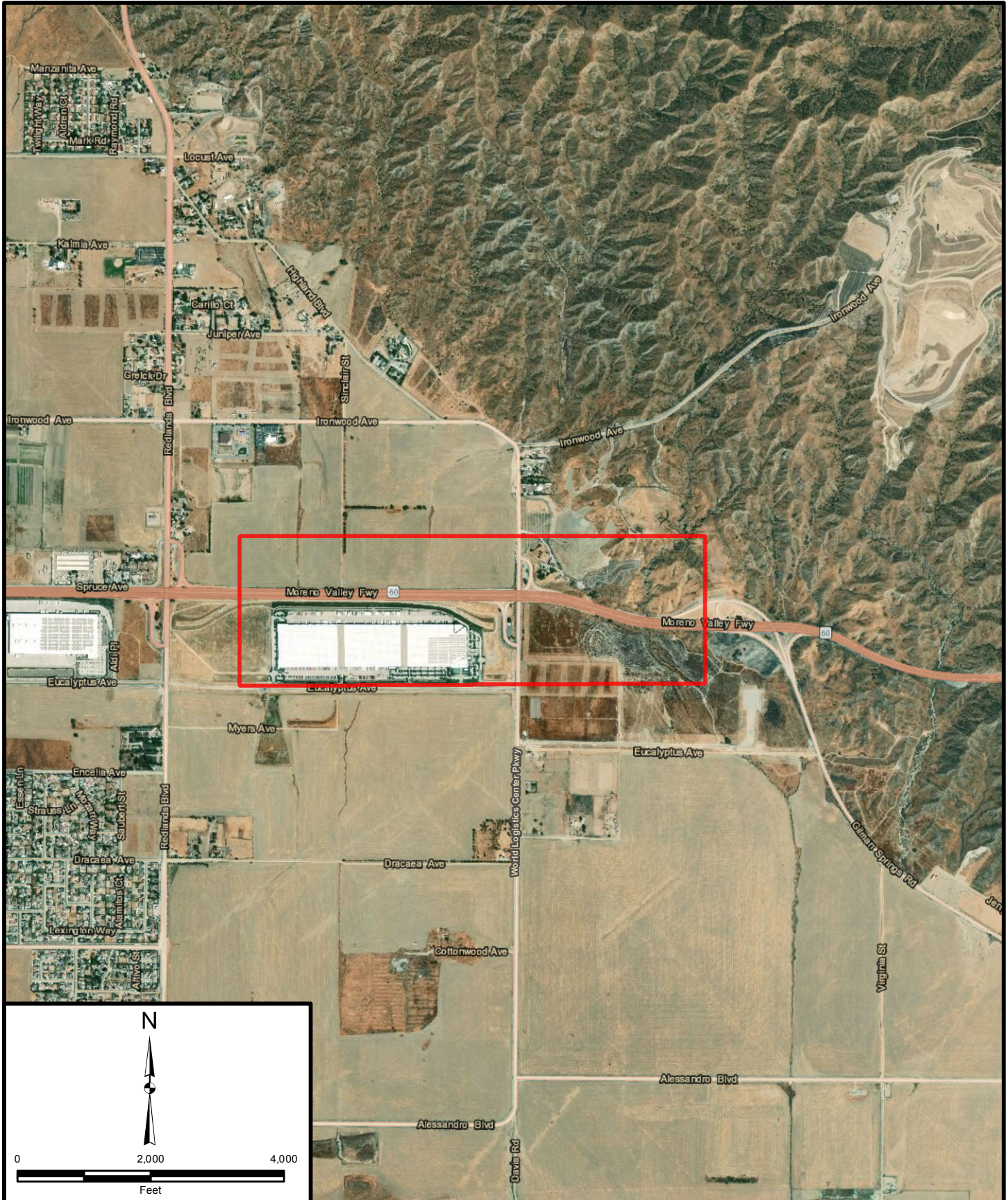

Project: 10326.002	Eng/Geol: SIS/RFR
Scale: 1" = 2,000'	Date: December 2015
Base Map: ESRI ArcGIS Online 2018	
Thematic Information: Leighton	
Author: Leighton Geomatics (mmurphy)	

SITE VICINITY MAP
 SR-60/World Logistics Center Parkway
 Interchange Improvements
 PM 20-22, Bridge No. 56-0488, EA 0M590, PN 0813000109
 Moreno Valley, California

Figure 1

Leighton

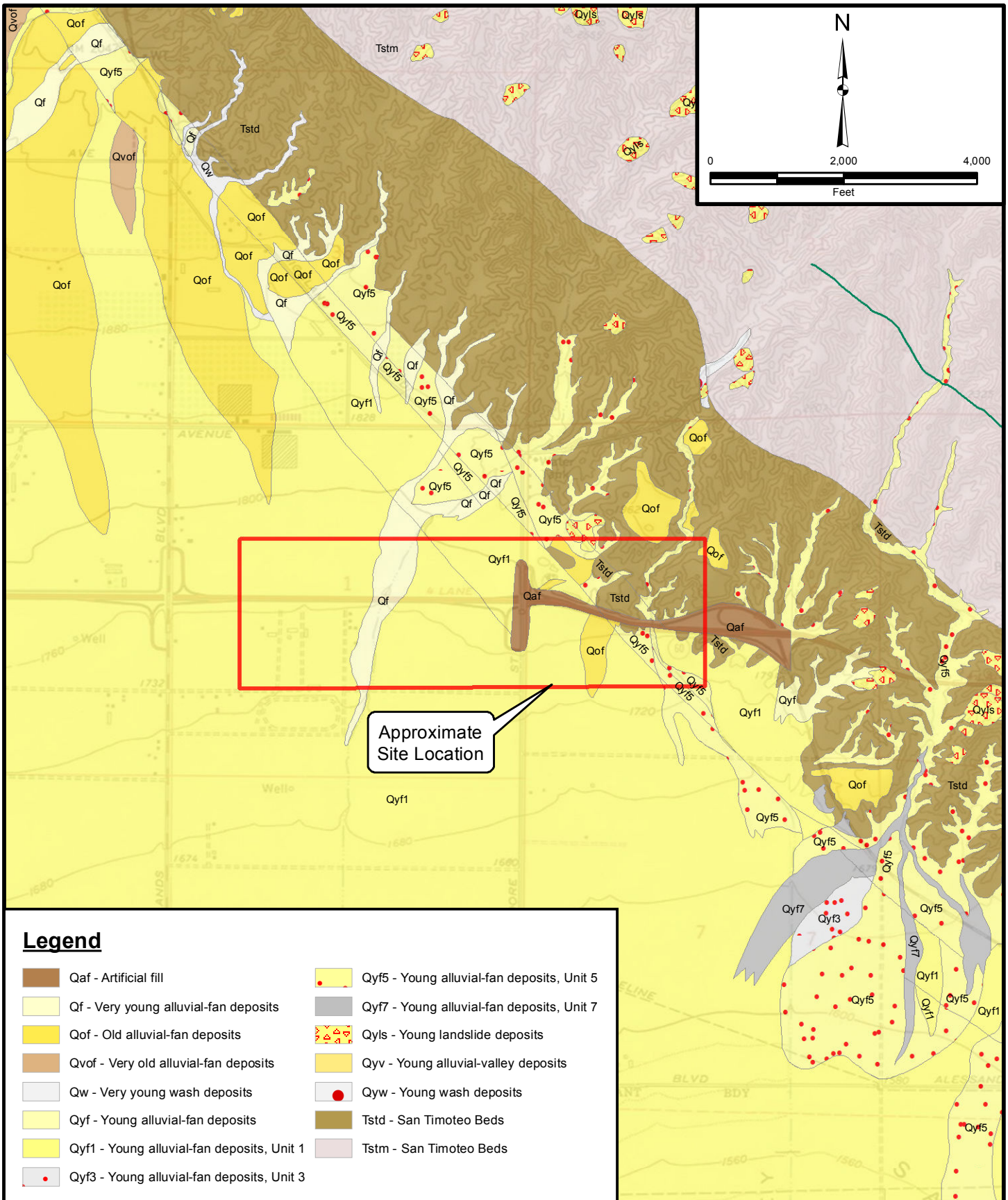

Legend

- Qaf - Artificial fill
- Qf - Very young alluvial-fan deposits
- Qof - Old alluvial-fan deposits
- Qvof - Very old alluvial-fan deposits
- Qw - Very young wash deposits
- Qyf - Young alluvial-fan deposits
- Qyf1 - Young alluvial-fan deposits, Unit 1
- Qyf3 - Young alluvial-fan deposits, Unit 3
- Qyf5 - Young alluvial-fan deposits, Unit 5
- Qyf7 - Young alluvial-fan deposits, Unit 7
- Qyls - Young landslide deposits
- Qyv - Young alluvial-valley deposits
- Qyw - Young wash deposits
- Tstd - San Timoteo Beds
- Tstm - San Timoteo Beds

Project: 10326.002	Eng/Geol: SIS/RFR
Scale: 1" = 2,000'	Date: December 2015
<small>Base Map: ESRI ArcGIS Online 2018 Geology: USGS, 2006, Geologic map of the San Bernardino and Santa Ana 30' x 60' quadrangles, California, Version 1.0, Open File Report 2006-1217 Author: Leighton Geomatics (mmurphy)</small>	

REGIONAL GEOLOGY MAP
 SR-60/World Logistics Center Parkway
 Interchange Improvements
 PM 20-22, Bridge No. 56-0488, EA 0M590, PN 0813000109
 Moreno Valley, California

Figure 2



Leighton

Legend

- Riverside County Database Fault
- Riverside County Database Fault Zone

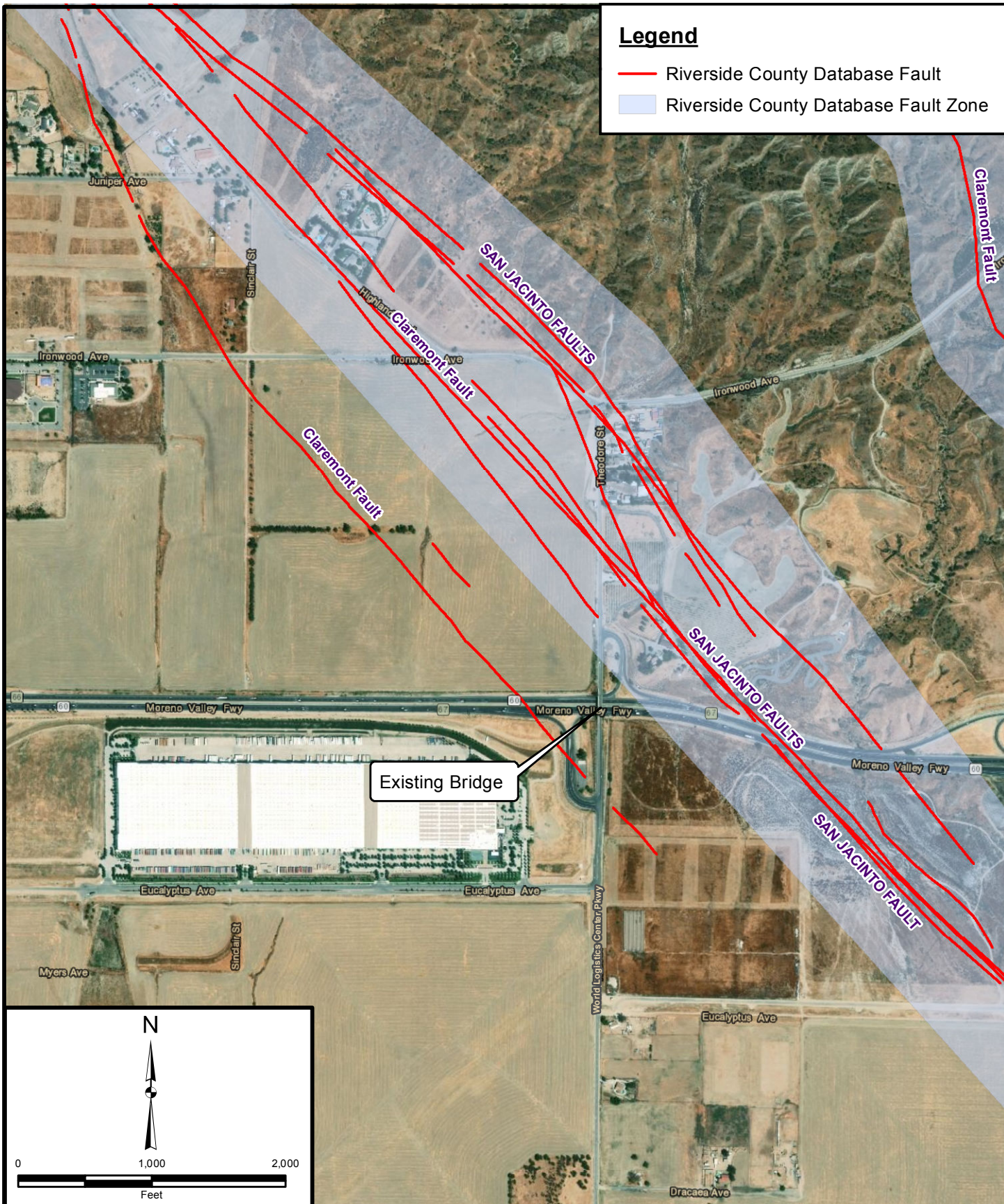

N

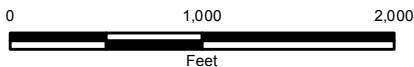

Project: 10326.002

Eng/Geol: SIS/RFR

Scale: 1" = 1,000'

Date: December 2015

Base Map: ESRI ArcGIS Online 2018
 Faults: Riverside County, Alquist-Priolo

Author: Leighton Geomatics (mmurphy)

REGIONAL FAULT ZONE MAP

SR-60/World Logistics Center Parkway
 Interchange Improvements
 PM 20-22, Bridge No. 56-0488, EA 0M590, PN 0813000109
 Moreno Valley, California

Figure 3



Leighton

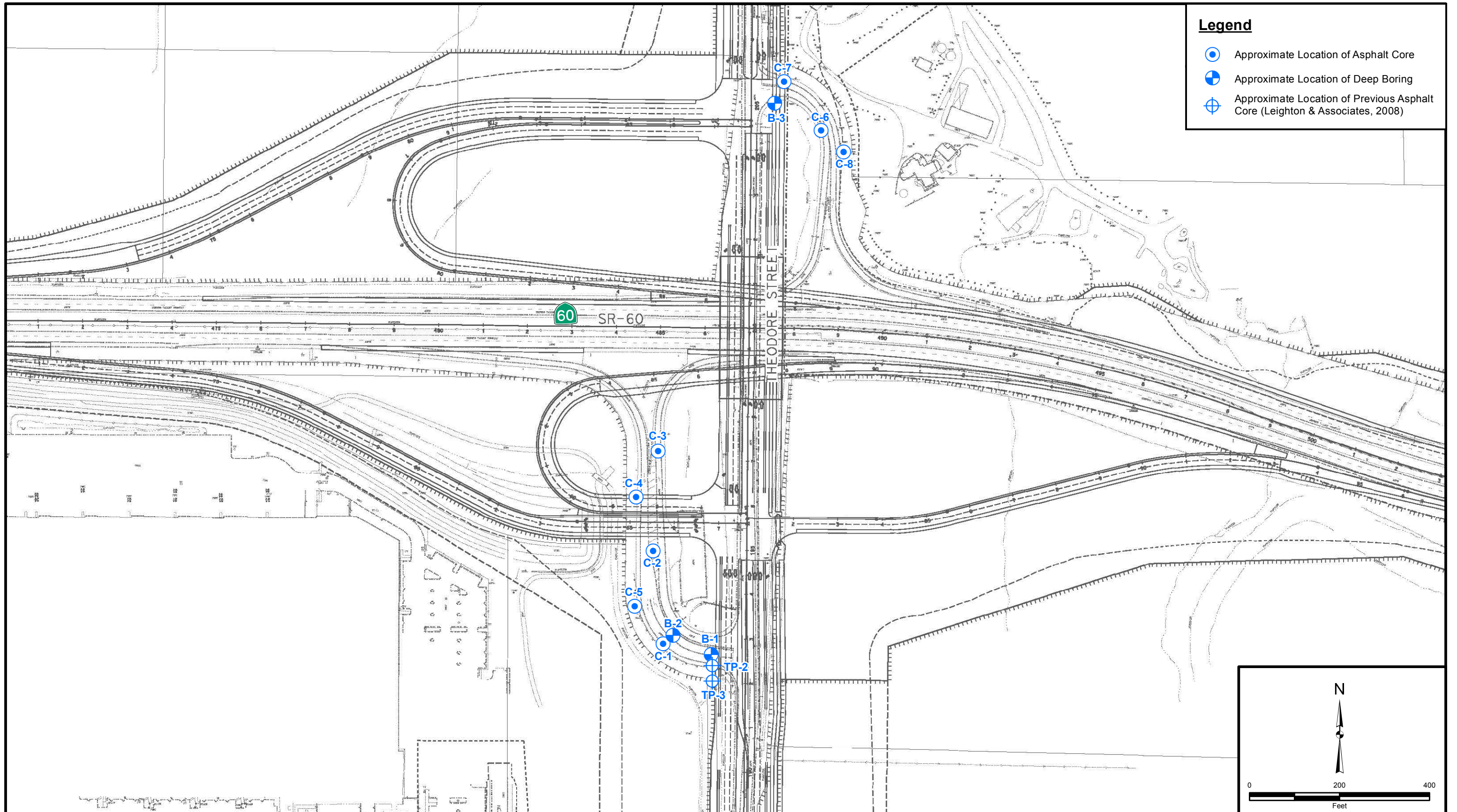

Project: 10326.002	Eng/Geol: SIS/RFR
Scale: 1" = 200'	Date: December 2015
Reference: RBF, SR-60/Theodore Street Interchange Project, Alternative 2/6, Modified Spread Diamond, March 2015.	
Author: Leighton Geomatics (mmurphy)	

PROPOSED IMPROVEMENTS/PREVIOUS BORINGS

SR-60/World Logistics Center Parkway
 Interchange Improvements
 PM 20-22, Bridge No. 56-0488, EA 0M590, PN 0813000109
 Moreno Valley, California

Figure 4



Leighton

APPENDIX A

Existing Bridge LOTB and Previous Exploratory Borings Logs/Test Pits and Laboratory Test Results



PROJECT NO.	STATE	F.A. PROJECT NO.	SHEET NO.	TOTAL SHEETS
7	CALIF.		128	125

DATE: 10/22/42
 DRAWN BY: [Signature]
 CHECKED BY: [Signature]
 APPROVED BY: [Signature]
 DATE: October 22, 1942

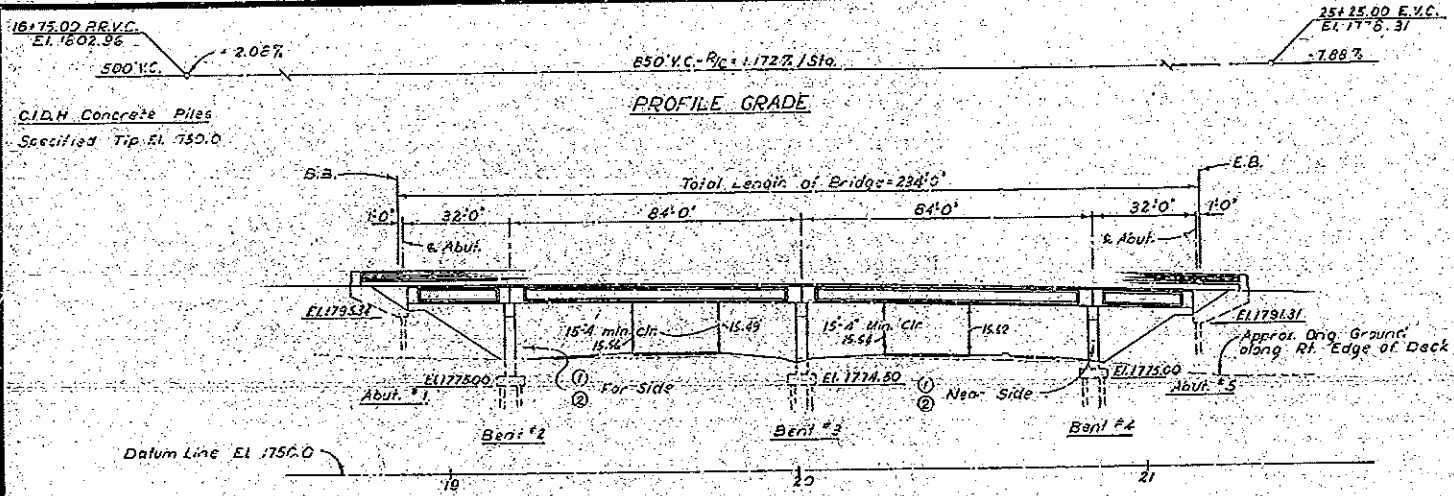

ELEVATION
 Scale: 1" = 20'-0"

- ① = Point Bridge No. & Date
- ② = Point Theodore St. C.C.
- ③ Indicates point of minimum vertical clearance.

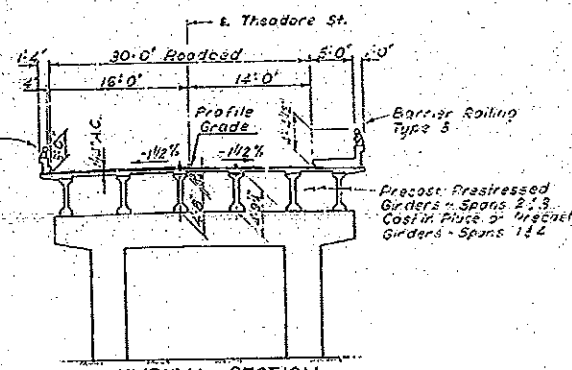

TYPICAL SECTION
 Scale: 1/2" = 1'-0"

INDEX TO PLANS

Sheet No.	Title
1	General Plan
2	Foundation Plan
3	Abutment Details
4	Bent Details
5	Typical Sections
6	Girder Layout & Grid Grades
7	Girder Details Spans 1 & 4 (Precast All)
8	Girder Details Spans 2 & 3 (Cast-in-Place All)
9	Prestressed "I" Girder
10	Diaphragm Details
11	Barrier Railing Sheet No. 1
12	Barrier Railing Sheet No. 2
13	Log of Test Borings

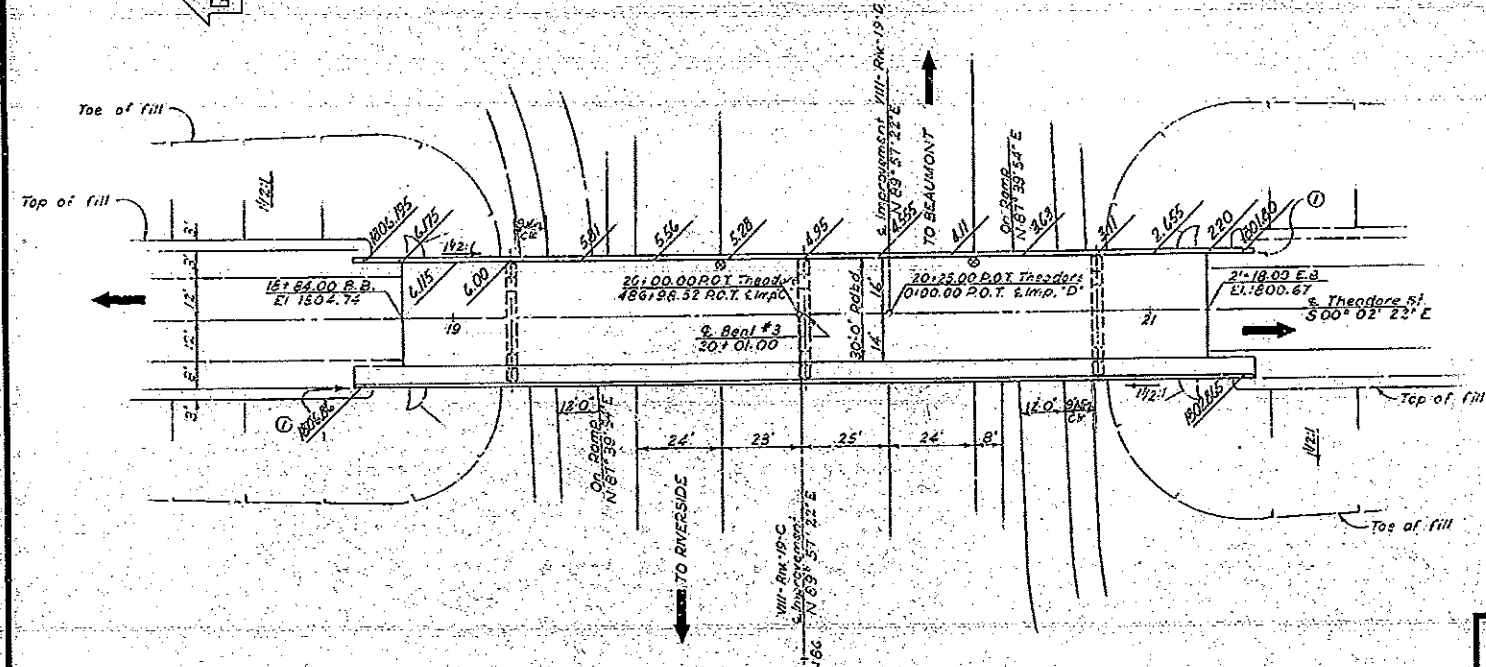

PLAN
 Scale: 1" = 20'-0"

AS BUILT PLANS
 Contract No. 64-8V13C1
 Date Completed [blank]
 Document No. 88800857

APPROXIMATE QUANTITIES

* STRUCTURE EXCAVATION (BRIDGE)	280 C.Y.
* STRUCTURE BACKFILL (BRIDGE)	165 C.Y.
ASPHALT CONCRETE	56 TONS
16" C.I.J.H. CONCRETE PILING	1,590 L.F.
FURNISHING 90,000 PSI CONCRETE GIRDERS (80'-29') 12M	12 EA.
ERECTING 90,000 PSI CONCRETE GIRDERS	12 EA.
* CLASS "A" CONCRETE (BRIDGE)	500 C.Y.
RUBBER WATERSTOPS	112 L.F.
JOINT SEALER	112 L.F.
* BAR REINFORCING STEEL (BRIDGE)	95,000 LBS.
BARRIER RAILING (TYPE 1)	192 L.F.
BARRIER RAILING (TYPE 5)	292 L.F.

* FINAL QUANTITIES
 @ 5,000 PSI.

THIS SET OF PLANS HAS BEEN CORRECTED TO CORRESPOND TO THE "AS BUILT" PRINTS DATED May 26, 1944 AS SUBMITTED BY REQUEST ENGINEER GENERAL CONTRACTOR
 ERRORS CORRECTED BY: [Signature] DATE: 5-2-1944

DESIGN	By R.E. Stearns 2-12-42	Checked by [Signature]
DETAILS	By [Signature] 2-12-42	Checked by [Signature]
LAYOUT	By [Signature]	Checked by [Signature]
QUANTITIES	By [Signature]	Checked by [Signature]
SPECIFICATIONS	By [Signature]	Checked by [Signature]

STATE OF CALIFORNIA
 DEPARTMENT OF PUBLIC WORKS
 DIVISION OF HIGHWAYS

64-8V13C1

THEODORE STREET OVERCROSSING
 LOCATED ABOUT 10.6 MILES EAST OF THE EAST CITY LIMITS OF RIVERSIDE IN RIVERSIDE COUNTY

GENERAL PLAN

SCALE AS NOTED BRIDGE 56-488 B1C DRAWING 56-488-1

I HEREBY CERTIFY THAT THIS IS A TRUE AND ACCURATE COPY OF THE ABOVE DOCUMENT TAKEN UNDER MY DIRECTION AND CONTROL ON THIS DATE IN SACRAMENTO, CALIFORNIA PURSUANT TO AUTHORIZATION BY THE DIRECTOR OF PUBLIC WORKS
 DATE 1-20-72 SIGNATURE [Signature] SR RMO

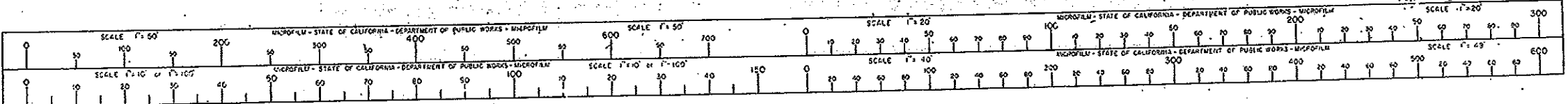

- UTILITIES**
- PP # 11191 CWT
2 Wires N. to S. @ El. 1824.
 - PP # 11190 CWT
2 Wires N. to S. @ El. 1820
 - GP # 14913
1 G. Wire to E. @ El. 1807
 - PP # 316248
2 H.V.C. to E. @ El. 1830
2 H.V.C. to N. @ El. 1829
1 G. Wire to W. @ El. 1829
1 G. Wire to S. @ El. 1829
 - GP # 15168
1 G. Wire to N. @ El. 1800
 - PP # 1189 CWT
2 Wires N. to S. @ El. 181E
 - PP # 1188 CWT
2 Wires N. to S. @ El. 1797

CURVE DATA

<p>Ⓐ R = 150' Δ = 82° 34' 11" L = 216.167' T = 131.708' N 50,245.647 E 5,012.725</p>	<p>Ⓑ R = 150' Δ = 85° 43' 59" L = 224.449' T = 139.225' N 49,823.392 E 4,939.183</p>	<p>Ⓒ R = 3013' Δ = 17° 58' 46" L = 945.48' T = 476.66' N 46,999.076 E 5,099.910</p>	<p>Ⓓ R = 2989' Δ = 03° 53' 08" L = 202.701' T = 94.083' N 46,993.454 E 5,219.292</p>
--	--	---	--

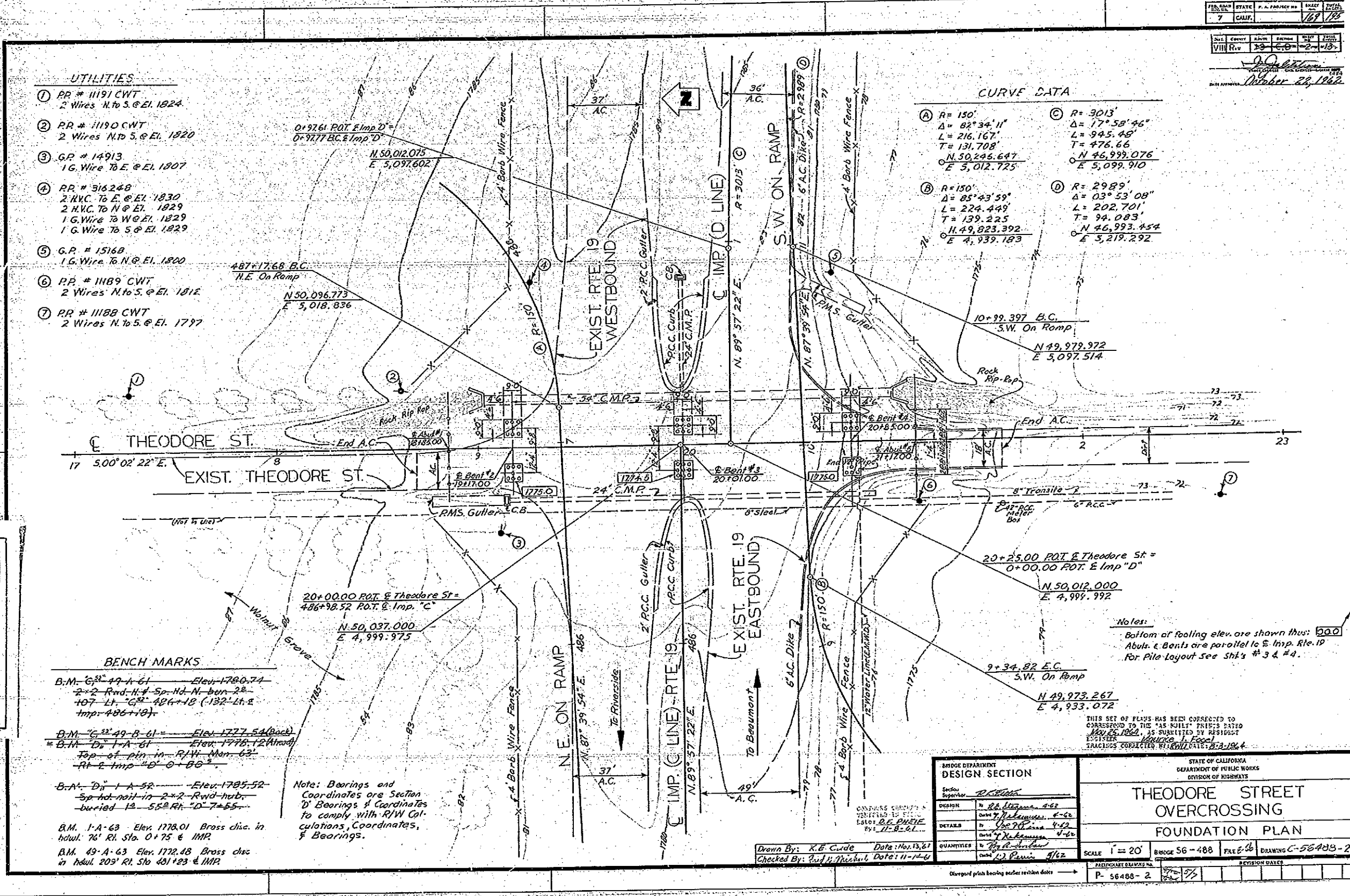

AS BUILT PLANS
 Contract No. 44-8V13E1
 Date Completed _____
 Document No. 80000857

- BENCH MARKS**
- B.M. "G" 49-A-61 Elev. 1780.74
2x2 Rnd. H. Sp. Hd. N. ben. 2"
107 Lt. "G" 486+18 (132 Lt. E
Imp. 486+18)
 - B.M. "C" 49-B-61 Elev. 1777.54 (Back)
 - B.M. "D" 1-A-61 Elev. 1778.12 (Ahead)
Top of pin in R/W. Man. 63"
Rt. E. Imp. "D" 0+86
 - B.M. "D" 1-A-52 Elev. 1785.52
Sp. Hd. nail in 2x2 Rnd. H. ben.
buried 12 55 R. "D" 7+55
 - B.M. 1-A-63 Elev. 1778.01 Brass disc in
hdwl. 76' Ri. Sta. 0+75 & IMP.
 - B.M. 49-A-63 Elev. 1772.48 Brass disc
in hdwl. 209' Ri. Sta. 481+23 & IMP.

Note: Bearings and Coordinates are Section 'D' Bearings & Coordinates to comply with R/W Calculations, Coordinates, & Bearings.

Notes:
 Bottom of footing elev. are shown thus: 500
 Abut. & Bents are parallel to E. Imp. Rte. 19
 For Pile Layout See Shk's #3 & #4.

THIS SET OF PLANS HAS BEEN CORRECTED TO CORRESPOND TO THE "AS BUILT" PRINTS DATED May 25, 1962, AS SUBMITTED BY RESIDENT ENGINEER - *[Signature]* - FOSCH. TRACINGS CORRECTED BY: *[Signature]* DATE: 12-7-1964

BRIDGE DEPARTMENT DESIGN SECTION		STATE OF CALIFORNIA DEPARTMENT OF PUBLIC WORKS DIVISION OF HIGHWAYS	
Section Supervisor	<i>[Signature]</i>	THEODORE STREET OVERCROSSING FOUNDATION PLAN	
DESIGN	By: <i>[Signature]</i> 4-62 Date: <i>[Signature]</i> 4-62		
DETAILS	By: <i>[Signature]</i> 4-62 Date: <i>[Signature]</i> 4-62	SCALE 1" = 20'	BRIDGE 56-488
QUANTITIES	By: <i>[Signature]</i> Date: <i>[Signature]</i> 4/62	FILE 66	DRAWING C-56488-2
Drawn By: K.E. Curde Date: Nov. 13, 61 Checked By: Paul H. Thibault Date: 11-14-61		SECTION DANCE	

I HEREBY CERTIFY THAT THIS IS A TRUE AND ACCURATE COPY OF THE ABOVE DOCUMENT TAKEN UNDER MY DIRECTION AND CONTROL ON THIS DATE IN SACRAMENTO, CALIFORNIA PURSUANT TO AUTHORIZATION BY THE DIRECTOR OF PUBLIC WORKS.
 DATE 1-20-72 SIGNATURE: *[Signature]* TITLE: SR RMO

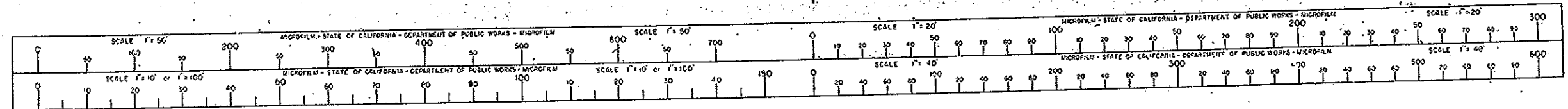

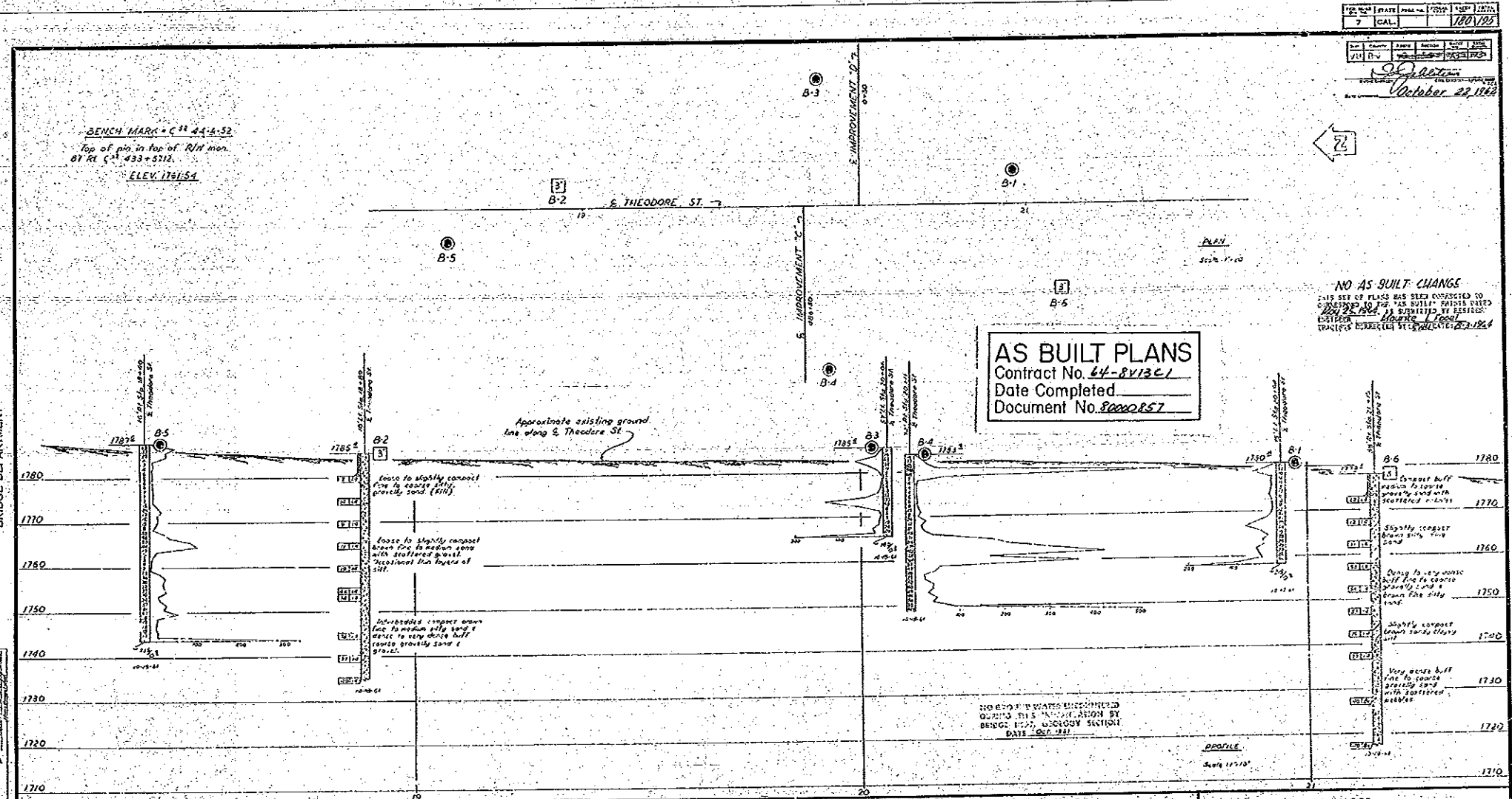

BRIDGE DEPARTMENT
 THEODORE ST. OVERCROSSING
 LOG OF TEST BORINGS
 DRAWING NO. 56-488-13

CLASSIFICATION OF MATERIAL BASED ON STANDARD GRADE SIZE LIMITS		LEGEND OF EARTH MATERIALS		LEGEND OF BORING OPERATIONS			NOTE
<p>DIAGRAM SHOWING THE BASIS FOR ESTIMATES OF GRADE SIZE DISTRIBUTION USED IN DETERMINATION OF CLASS NAME. IF GRAVEL IS PRESENT OF APPRECIABLE AMOUNTS THE TERM "GRAVELLY" MAY BE ADDED TO THE CLASS NAME, I.E., "GRAVELLY SAND". THE TERMS "COARSE", "MEDIUM" AND "FINE" WHEN USED TO DESCRIBE SAND, SILT AND GRAVEL REFER TO STANDARD GRADE SIZE LIMITS.</p>		<p>GRAVEL</p> <p>SAND</p> <p>SILT</p> <p>CLAY</p> <p>SANDY CLAY OR CLAYEY SAND</p> <p>SANDY SILT OR SILTY SAND</p> <p>SILTY CLAY OR CLAYEY SILT</p> <p>PEAT AND/OR ORGANIC MATTER</p> <p>FILL MATERIAL</p> <p>IGNEOUS ROCK</p> <p>SEDIMENTARY ROCK</p> <p>METAMORPHIC ROCK</p>		<p>Penetrometer</p> <p>2 1/2" Cone Penetrometer</p> <p>Sampler Boring (SMB)</p> <p>Rotary Boring (WB)</p> <p>Auger Boring (AB)</p> <p>Jet Boring</p> <p>Cable Boring</p> <p>TEST PIT</p> <p>1" SOIL TUBE</p> <p>Rotary Boring</p> <p>Penetration Boring</p>			<p>NOTE</p> <p>Classification of earth material as shown on this sheet is based upon field inspection and is not to be construed to imply mechanical analysis.</p> <p>THEODORE ST. OVERCROSSING</p> <p>LOG OF TEST BORINGS</p> <p>SCALE AS SHOWN BRIDGE 56-488 FILE DRAWING 56-488-13</p>

180

I HEREBY CERTIFY THAT THIS IS A TRUE AND ACCURATE COPY OF THE ABOVE DOCUMENT FILED UNDER MY DIRECTION AND CONTROL ON THIS DATE IN SACRAMENTO, CALIFORNIA PURSUANT TO AUTHORIZATION BY THE DIRECTOR OF PUBLIC WORKS.

DATE 1-10-72 SIGNATURE *[Signature]* SR RMA

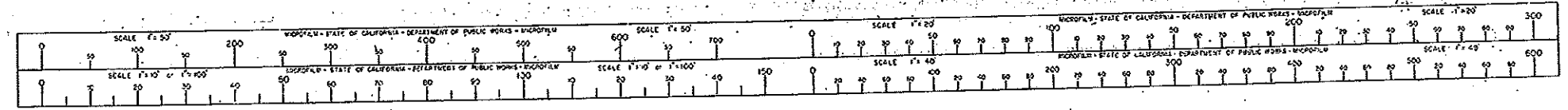

GEOTECHNICAL BORING LOG B-1

Project No.	111061123	Date Drilled	5-10-10
Project	Theodore Pavement Evaluation/SR60 Ramps	Logged By	JTD
Drilling Co.	BAJA EXPLORATION	Hole Diameter	8"
Drilling Method	Hollow Stem Auger - 140lb	Ground Elevation	~1761'
Location	Eastbound on-ramp Sta 479+40	Sampled By	JTD

Elevation Feet	Depth Feet	Graphic Log	Attitudes	Sample No.	Blows Per 6 Inches	Dry Density pcf	Moisture Content, %	Soil Class. (U.S.C.S.)	SOIL DESCRIPTION	Type of Tests
	0	N S							This Soil Description applies only to a location of the exploration at the time of sampling. Subsurface conditions may differ at other locations and may change with time. The description is a simplification of the actual conditions encountered. Transitions between soil types may be gradual.	
	0			R1	4			SM	<u>QUATERNARY ALLUVIUM (Qal)</u>	
				B1	10 14				SILTY SAND, gray brown, damp, fine to coarse, few gravel 0-18": SANDY SILT, olive, damp to moist, fine, trace fine gravel	
				R2	8 3 12	112	11		SILTY SAND, gray brown, loose, moist, fine, root hairs 44% -200, EI=33	-200, EI
	5			R3	2 3 3	114	7		SILTY SAND, gray brown, loose, moist, fine, few angular gravel	
				R4	2 4 5				SILTY SAND, light gray, loose, moist, fine to very fine	
	10			R5	2 4 5	112	9		SILTY SAND, yellow brown, loose, moist, fine	
				R6	9 8 7				SILTY SAND, light brown brown gray, loose, moist, fine	
	20								Total Depth 16.5' No Groundwater Encountered Backfilled with cuttings 5/10/10	
	25									
	30									

SAMPLE TYPES:		TYPE OF TESTS:	
B BULK SAMPLE	-200 % FINES PASSING	DS DIRECT SHEAR	SA SIEVE ANALYSIS
C CORE SAMPLE	AL ATTERBERG LIMITS	EI EXPANSION INDEX	SE SAND EQUIVALENT
G GRAB SAMPLE	CN CONSOLIDATION	H HYDROMETER	SG SPECIFIC GRAVITY
R RING SAMPLE	CO COLLAPSE	MD MAXIMUM DENSITY	UC UNCONFINED COMPRESSIVE STRENGTH
S SPLIT SPOON SAMPLE	CR CORROSION	PP POCKET PENETROMETER	
T TUBE SAMPLE	CU UNDRAINED TRIAXIAL	RV R VALUE	



GEOTECHNICAL BORING LOG B-2

Project No. 111061123
Project Theodore Pavement Evaluation/SR60 Ramps
Drilling Co. BAJA EXPLORATION
Drilling Method Hollow Stem Auger - 140lb
Location Eastbound on-ramp Sta 480+50

Date Drilled 5-10-10
Logged By JTD
Hole Diameter 8"
Ground Elevation ~1766'
Sampled By JTD

Elevation Feet	Depth Feet	Graphic Log	Attitudes	Sample No.	Blows Per 6 Inches	Dry Density pcf	Moisture Content, %	Soil Class. (U.S.C.S.)	SOIL DESCRIPTION	Type of Tests
	0	N S		R1	9			(SM)g	This Soil Description applies only to a location of the exploration at the time of sampling. Subsurface conditions may differ at other locations and may change with time. The description is a simplification of the actual conditions encountered. Transitions between soil types may be gradual. ARTIFICIAL FILL (Afu) SILTY SAND, gray brown, damp to moist, gravely, fine to coarse 6-18": SANDY SILT, olive brown, hard, moist, fine RV=52	RV, SA
				B1	16 21	121	9	ML SM		
				R2	5 5 6	114	8	SM	QUATERNARY ALLUVIUM (Qal) SILTY SAND, olive brown, loose, moist, fine to medium	
	5			R3	4 7 8	101	8		SILTY SAND, brown, loose, moist, fine to medium	
	10								Total Depth 6.5' No Groundwater Encountered Backfilled with cuttings 5/10/10	
	15									
	20									
	25									
	30									

SAMPLE TYPES:

- B BULK SAMPLE
- C CORE SAMPLE
- G GRAB SAMPLE
- R RING SAMPLE
- S SPLIT SPOON SAMPLE
- T TUBE SAMPLE

TYPE OF TESTS:

- 200 % FINES PASSING
- AL ATTERBERG LIMITS
- CN CONSOLIDATION
- CO COLLAPSE
- CR CORROSION
- CU UNDRAINED TRIAXIAL

- DS DIRECT SHEAR
- EI EXPANSION INDEX
- H HYDROMETER
- MD MAXIMUM DENSITY
- PP POCKET PENETROMETER
- RV R VALUE

- SA SIEVE ANALYSIS
- SE SAND EQUIVALENT
- SG SPECIFIC GRAVITY
- UC UNCONFINED COMPRESSIVE STRENGTH



GEOTECHNICAL BORING LOG B-3

Project No. 111061123
Project Theodore Pavement Evaluation/SR60 Ramps
Drilling Co. BAJA EXPLORATION
Drilling Method Hollow Stem Auger - 140lb
Location Westbound on-ramp Sta 92+10

Date Drilled 5-10-10
Logged By JTD
Hole Diameter 8"
Ground Elevation ~1800'
Sampled By JTD

Elevation Feet	Depth Feet	Graphic Log	Attitudes	Sample No.	Blows Per 6 Inches	Dry Density pcf	Moisture Content, %	Soil Class. (U.S.C.S.)	SOIL DESCRIPTION	Type of Tests
This Soil Description applies only to a location of the exploration at the time of sampling. Subsurface conditions may differ at other locations and may change with time. The description is a simplification of the actual conditions encountered. Transitions between soil types may be gradual.										
0		N S		R1	10			(SM)g	ARTIFICIAL FILL (Af) SAND, light gray, damp, gravelly, fine to coarse 0-1.5': SILTY SAND, dark gray, medium dense, moist, fine	
				B1	12 16					
				R2	11 12 14	113	2	(SW)g	SAN TIMOTEO (Tstd) SAND, pale brown, medium dense, damp to moist, fine to coarse with angular gravel	
5				R3	6 9 14				SAND, pale brown, medium dense, damp to moist, fine to coarse with sub-angular to sub-rounded gravel	
10									Total Depth 6.5' No Groundwater Encountered Backfilled with cuttings 5/10/10	
15										
20										
25										
30										

SAMPLE TYPES:

- B BULK SAMPLE
- C CORE SAMPLE
- G GRAB SAMPLE
- R RING SAMPLE
- S SPLIT SPOON SAMPLE
- T TUBE SAMPLE

TYPE OF TESTS:

- 200 % FINES PASSING
- AL ATTERBERG LIMITS
- CN CONSOLIDATION
- CO COLLAPSE
- CR CORROSION
- CU UNDRAINED TRIAXIAL

- DS DIRECT SHEAR
- EI EXPANSION INDEX
- H HYDROMETER
- MD MAXIMUM DENSITY
- PP POCKET PENETROMETER
- RV R VALUE

- SA SIEVE ANALYSIS
- SE SAND EQUIVALENT
- SG SPECIFIC GRAVITY
- UC UNCONFINED COMPRESSIVE STRENGTH



GEOTECHNICAL BORING LOG C-1

Project No. 111061123
Project Theodore Pavement Evaluation/SR60 Ramps
Drilling Co. BAJA EXPLORATION
Drilling Method Hollow Stem Auger - 140lb
Location Eastbound on-ramp Sta 480+50

Date Drilled 5-10-10
Logged By JTD
Hole Diameter 8"
Ground Elevation ~1766'
Sampled By JTD

Elevation Feet	Depth Feet	Graphic Log	Attitudes	Sample No.	Blows Per 6 Inches	Dry Density pcf	Moisture Content, %	Soil Class. (U.S.C.S.)	SOIL DESCRIPTION	Type of Tests
	0	N S							This Soil Description applies only to a location of the exploration at the time of sampling. Subsurface conditions may differ at other locations and may change with time. The description is a simplification of the actual conditions encountered. Transitions between soil types may be gradual. 0.30' AC over 0.55' AB SILTY SAND, olive brown, moist, fine to medium	
	5									
	10									
	15									
	20									
	25									
	30									

- | | | | |
|---|--|---|--|
| SAMPLE TYPES:
B BULK SAMPLE
C CORE SAMPLE
G GRAB SAMPLE
R RING SAMPLE
S SPLIT SPOON SAMPLE
T TUBE SAMPLE | TYPE OF TESTS:
-200 % FINES PASSING
AL ATTERBERG LIMITS
CN CONSOLIDATION
CO COLLAPSE
CR CORROSION
CU UNDRAINED TRIAXIAL | DS DIRECT SHEAR
EI EXPANSION INDEX
H HYDROMETER
MD MAXIMUM DENSITY
PP POCKET PENETROMETER
RV R VALUE | SA SIEVE ANALYSIS
SE SAND EQUIVALENT
SG SPECIFIC GRAVITY
UC UNCONFINED COMPRESSIVE STRENGTH |
|---|--|---|--|



GEOTECHNICAL BORING LOG C-2

Project No. 111061123
Project Theodore Pavement Evaluation/SR60 Ramps
Drilling Co. BAJA EXPLORATION
Drilling Method Hollow Stem Auger - 140lb
Location Eastbound on-ramp

Date Drilled 5-10-10
Logged By JTD
Hole Diameter 8"
Ground Elevation ~1770'
Sampled By JTD

Elevation Feet	Depth Feet	Graphic Log	Attitudes	Sample No.	Blows Per 6 Inches	Dry Density pcf	Moisture Content, %	Soil Class. (U.S.C.S.)	SOIL DESCRIPTION	Type of Tests
	0	N S							This Soil Description applies only to a location of the exploration at the time of sampling. Subsurface conditions may differ at other locations and may change with time. The description is a simplification of the actual conditions encountered. Transitions between soil types may be gradual.	
								SM	0.30' AC over 0.55' AB SILTY SAND, olive brown, moist, fine to medium	SA, RV
	5									
	10									
	15									
	20									
	25									
	30									

SAMPLE TYPES:

- B BULK SAMPLE
- C CORE SAMPLE
- G GRAB SAMPLE
- R RING SAMPLE
- S SPLIT SPOON SAMPLE
- T TUBE SAMPLE

TYPE OF TESTS:

- 200 % FINES PASSING
- AL ATTERBERG LIMITS
- CN CONSOLIDATION
- CO COLLAPSE
- CR CORROSION
- CU UNDRAINED TRIAXIAL

- DS DIRECT SHEAR
- EI EXPANSION INDEX
- H HYDROMETER
- MD MAXIMUM DENSITY
- PP POCKET PENETROMETER
- RV R VALUE

- SA SIEVE ANALYSIS
- SE SAND EQUIVALENT
- SG SPECIFIC GRAVITY
- UC UNCONFINED COMPRESSIVE STRENGTH



GEOTECHNICAL BORING LOG C-3

Project No. 111061123
Project Theodore Pavement Evaluation/SR60 Ramps
Drilling Co. BAJA EXPLORATION
Drilling Method Hollow Stem Auger - 140lb
Location Eastbound on-ramp Sta 484+60

Date Drilled 5-10-10
Logged By JTD
Hole Diameter 8"
Ground Elevation ~1775'
Sampled By JTD

Elevation Feet	Depth Feet	Graphic Log	Attitudes	Sample No.	Blows Per 6 Inches	Dry Density pcf	Moisture Content, %	Soil Class. (U.S.C.S.)	SOIL DESCRIPTION	Type of Tests
	0	N S							This Soil Description applies only to a location of the exploration at the time of sampling. Subsurface conditions may differ at other locations and may change with time. The description is a simplification of the actual conditions encountered. Transitions between soil types may be gradual.	
								SM	0.30' AC over 0.55' AB SILTY SAND, olive brown, moist, fine to medium	SA, RV
	5									
	10									
	15									
	20									
	25									
	30									

SAMPLE TYPES:

- B BULK SAMPLE
- C CORE SAMPLE
- G GRAB SAMPLE
- R RING SAMPLE
- S SPLIT SPOON SAMPLE
- T TUBE SAMPLE

TYPE OF TESTS:

- 200 % FINES PASSING
- AL ATTERBERG LIMITS
- CN CONSOLIDATION
- CO COLLAPSE
- CR CORROSION
- CU UNDRAINED TRIAXIAL

- DS DIRECT SHEAR
- EI EXPANSION INDEX
- H HYDROMETER
- MD MAXIMUM DENSITY
- PP POCKET PENETROMETER
- RV R VALUE

- SA SIEVE ANALYSIS
- SE SAND EQUIVALENT
- SG SPECIFIC GRAVITY
- UC UNCONFINED COMPRESSIVE STRENGTH



GEOTECHNICAL BORING LOG C-4

Project No. 111061123
Project Theodore Pavement Evaluation/SR60 Ramps
Drilling Co. BAJA EXPLORATION
Drilling Method Hollow Stem Auger - 140lb
Location Eastbound off-ramp Sta 486+80

Date Drilled 5-10-10
Logged By JTD
Hole Diameter 8"
Ground Elevation ~1773'
Sampled By JTD

Elevation Feet	Depth Feet	Graphic Log	Attitudes	Sample No.	Blows Per 6 Inches	Dry Density pcf	Moisture Content, %	Soil Class. (U.S.C.S.)	SOIL DESCRIPTION	Type of Tests
	0	N S							This Soil Description applies only to a location of the exploration at the time of sampling. Subsurface conditions may differ at other locations and may change with time. The description is a simplification of the actual conditions encountered. Transitions between soil types may be gradual.	
	0	0.15' overlay over 0.15' AC / 0.40' AB							ARTIFICIAL FILL (Af)	
	3.5	R1			6 12 21	129	12	SM	SILTY SAND, olive brown, medium dense, moist, fine, trace fine gravel	RV
	5								Total Depth 3.5' No Groundwater Encountered Backfilled with cuttings and cold patch AC 5/10/10	
	10									
	15									
	20									
	25									
	30									

SAMPLE TYPES:

- B BULK SAMPLE
- C CORE SAMPLE
- G GRAB SAMPLE
- R RING SAMPLE
- S SPLIT SPOON SAMPLE
- T TUBE SAMPLE

TYPE OF TESTS:

- 200 % FINES PASSING
- AL ATTERBERG LIMITS
- CN CONSOLIDATION
- CO COLLAPSE
- CR CORROSION
- CU UNDRAINED TRIAXIAL

- DS DIRECT SHEAR
- EI EXPANSION INDEX
- H HYDROMETER
- MD MAXIMUM DENSITY
- PP POCKET PENETROMETER
- RV R VALUE

- SA SIEVE ANALYSIS
- SE SAND EQUIVALENT
- SG SPECIFIC GRAVITY
- UC UNCONFINED COMPRESSIVE STRENGTH



GEOTECHNICAL BORING LOG C-5

Project No. 111061123
Project Theodore Pavement Evaluation/SR60 Ramps
Drilling Co. BAJA EXPLORATION
Drilling Method Hollow Stem Auger - 140lb
Location Eastbound off-ramp Sta 489+20

Date Drilled 5-10-10
Logged By JTD
Hole Diameter 8"
Ground Elevation ~1765'
Sampled By JTD

Elevation Feet	Depth Feet	Graphic Log	Attitudes	Sample No.	Blows Per 6 Inches	Dry Density pcf	Moisture Content, %	Soil Class. (U.S.C.S.)	SOIL DESCRIPTION	Type of Tests
	0	N S							This Soil Description applies only to a location of the exploration at the time of sampling. Subsurface conditions may differ at other locations and may change with time. The description is a simplification of the actual conditions encountered. Transitions between soil types may be gradual. 0.10' overlay over 0.23' AC / 0.40' AB <u>ARTIFICIAL FILL (Af)</u>	
		N S		R1	6 12 22	131	13	ML	SANDY SILT, olive, hard, moist, fine, trace fine angular gravel	RV
	5								Total Depth 3.5' No Groundwater Encountered Backfilled with cuttings and cold patch AC 5/10/10	
	10									
	15									
	20									
	25									
	30									

SAMPLE TYPES:

- B BULK SAMPLE
- C CORE SAMPLE
- G GRAB SAMPLE
- R RING SAMPLE
- S SPLIT SPOON SAMPLE
- T TUBE SAMPLE

TYPE OF TESTS:

- 200 % FINES PASSING
- AL ATTERBERG LIMITS
- CN CONSOLIDATION
- CO COLLAPSE
- CR CORROSION
- CU UNDRAINED TRIAXIAL

- DS DIRECT SHEAR
- EI EXPANSION INDEX
- H HYDROMETER
- MD MAXIMUM DENSITY
- PP POCKET PENETROMETER
- RV R VALUE



- SA SIEVE ANALYSIS
- SE SAND EQUIVALENT
- SG SPECIFIC GRAVITY
- UC UNCONFINED COMPRESSIVE STRENGTH



GEOTECHNICAL BORING LOG C-6

Project No. 111061123
Project Theodore Pavement Evaluation/SR60 Ramps
Drilling Co. BAJA EXPLORATION
Drilling Method Hollow Stem Auger - 140lb
Location Westbound on-ramp Sta 93+85

Date Drilled 5-10-10
Logged By JTD
Hole Diameter 8"
Ground Elevation ~1795'
Sampled By JTD

Elevation Feet	Depth Feet	Graphic Log	Attitudes	Sample No.	Blows Per 6 Inches	Dry Density pcf	Moisture Content, %	Soil Class. (U.S.C.S.)	SOIL DESCRIPTION	Type of Tests
	0	N S							This Soil Description applies only to a location of the exploration at the time of sampling. Subsurface conditions may differ at other locations and may change with time. The description is a simplification of the actual conditions encountered. Transitions between soil types may be gradual.	
	0								0.10' overlay over 0.20' AC / 0.55' AB	
				R1	6 19 21	118	5	(SW)g	SAN TIMOTEO (Tstd) SAND, pale brown, dense, moist, fine to coarse, few sub-rounded gravel	RV
	5								Total Depth 3.5' No Groundwater Encountered Backfilled with cuttings and cold patch AC 5/10/10	
	10									
	15									
	20									
	25									
	30									

SAMPLE TYPES:

- B BULK SAMPLE
- C CORE SAMPLE
- G GRAB SAMPLE
- R RING SAMPLE
- S SPLIT SPOON SAMPLE
- T TUBE SAMPLE

TYPE OF TESTS:

- 200 % FINES PASSING
- AL ATTERBERG LIMITS
- CN CONSOLIDATION
- CO COLLAPSE
- CR CORROSION
- CU UNDRAINED TRIAXIAL

- DS DIRECT SHEAR
- EI EXPANSION INDEX
- H HYDROMETER
- MD MAXIMUM DENSITY
- PP POCKET PENETROMETER
- RV R VALUE

- SA SIEVE ANALYSIS
- SE SAND EQUIVALENT
- SG SPECIFIC GRAVITY
- UC UNCONFINED COMPRESSIVE STRENGTH



GEOTECHNICAL BORING LOG C-7

Project No. 111061123
Project Theodore Pavement Evaluation/SR60 Ramps
Drilling Co. BAJA EXPLORATION
Drilling Method Hollow Stem Auger - 140lb
Location Westbound off-ramp Sta 92+45

Date Drilled 5-10-10
Logged By JTD
Hole Diameter 8"
Ground Elevation ~1799'
Sampled By JTD

Elevation Feet	Depth Feet	Graphic Log	Attitudes	Sample No.	Blows Per 6 Inches	Dry Density pcf	Moisture Content, %	Soil Class. (U.S.C.S.)	SOIL DESCRIPTION	Type of Tests
	0	N S							This Soil Description applies only to a location of the exploration at the time of sampling. Subsurface conditions may differ at other locations and may change with time. The description is a simplification of the actual conditions encountered. Transitions between soil types may be gradual.	
	0	0.30' AC / 0.65' AB							0.30' AC / 0.65' AB	
		QUATERNARY ALLUVIUM (Qal)							QUATERNARY ALLUVIUM (Qal)	
		SANDY SILT, dark gray, stiff, moist, fine, elastic		R1	2 3 6	116	15	ML	SANDY SILT, dark gray, stiff, moist, fine, elastic	
	5								Total Depth 3.5' No Groundwater Encountered Backfilled with cuttings and cold patch AC 5/10/10	
	10									
	15									
	20									
	25									
	30									

SAMPLE TYPES:

- B BULK SAMPLE
- C CORE SAMPLE
- G GRAB SAMPLE
- R RING SAMPLE
- S SPLIT SPOON SAMPLE
- T TUBE SAMPLE

TYPE OF TESTS:

- 200 % FINES PASSING
- AL ATTERBERG LIMITS
- CN CONSOLIDATION
- CO COLLAPSE
- CR CORROSION
- CU UNDRAINED TRIAXIAL

- DS DIRECT SHEAR
- EI EXPANSION INDEX
- H HYDROMETER
- MD MAXIMUM DENSITY
- PP POCKET PENETROMETER
- RV R VALUE

- SA SIEVE ANALYSIS
- SE SAND EQUIVALENT
- SG SPECIFIC GRAVITY
- UC UNCONFINED COMPRESSIVE STRENGTH



GEOTECHNICAL BORING LOG C-8

Project No. 111061123
Project Theodore Pavement Evaluation/SR60 Ramps
Drilling Co. BAJA EXPLORATION
Drilling Method Hollow Stem Auger - 140lb
Location Westbound off-ramp Sta 94+50

Date Drilled 5-10-10
Logged By JTD
Hole Diameter 8"
Ground Elevation ~1791'
Sampled By JTD

Elevation Feet	Depth Feet	Graphic Log	Attitudes	Sample No.	Blows Per 6 Inches	Dry Density pcf	Moisture Content, %	Soil Class. (U.S.C.S.)	SOIL DESCRIPTION	Type of Tests
	0	N S							This Soil Description applies only to a location of the exploration at the time of sampling. Subsurface conditions may differ at other locations and may change with time. The description is a simplification of the actual conditions encountered. Transitions between soil types may be gradual.	
	0			R1	5 9 24	119	5	SM	0.25' AC / 0.60' AB SILTY SAND, gray brown, medium dense, moist fine to medium	RV
	5								Total Depth 3.5' No Groundwater Encountered Backfilled with cuttings and cold patch AC 5/10/10	
	10									
	15									
	20									
	25									
	30									

- | | | | |
|----------------------|-----------------------|------------------------|------------------------------------|
| SAMPLE TYPES: | | TYPE OF TESTS: | |
| B BULK SAMPLE | -200 % FINES PASSING | DS DIRECT SHEAR | SA SIEVE ANALYSIS |
| C CORE SAMPLE | AL ATTERBERG LIMITS | EI EXPANSION INDEX | SE SAND EQUIVALENT |
| G GRAB SAMPLE | CN CONSOLIDATION | H HYDROMETER | SG SPECIFIC GRAVITY |
| R RING SAMPLE | CO COLLAPSE | MD MAXIMUM DENSITY | UC UNCONFINED COMPRESSIVE STRENGTH |
| S SPLIT SPOON SAMPLE | CR CORROSION | PP POCKET PENETROMETER | |
| T TUBE SAMPLE | CU UNDRAINED TRIAXIAL | RV R VALUE | |



*** This log is a part of a report by Leighton and should not be used as a stand-alone document. ***



Leighton

EXPANSION INDEX of SOILS

ASTM D 4829

Project Name: THEODORE PAVEMENT EVAL. / 60 FWY. Tested By: JAP Date: 5/14/10
 Project No. : 111061-123 Checked By: JMB Date: 5/17/10
 Boring No: B-1 Depth (ft.) 0-5.0
 Sample No. : B-1 Location: **
 Sample Description: SILTY SAND WITH FEW TO LITTLE GRAVEL (SM), fine to medium grain, grayish brown. ** Trace AC in sample.

Dry Wt. of Soil + Cont. (gm.)	2683.6
Wt. of Container No. (gm.)	0.0
Dry Wt. of Soil (gm.)	2683.6
Weight Soil Retained on #4 Sieve	313.8
Percent Passing # 4	88.3

MOLDED SPECIMEN	Before Test	After Test
Specimen Diameter (in.)	4.01	4.01
Specimen Height (in.)	1.0000	1.0328
Wt. Comp. Soil + Mold (gm.)	609.1	642.2
Wt. of Mold (gm.)	191.2	191.2
Specific Gravity (Assumed)	2.70	2.70
Container No.	4	4
Wet Wt. of Soil + Cont. (gm.)	452.0	642.2
Dry Wt. of Soil + Cont. (gm.)	429.8	386.9
Wt. of Container (gm.)	152.0	191.2
Moisture Content (%)	8.0	16.6
Wet Density (pcf)	126.1	135.9
Dry Density (pcf)	116.7	116.6
Void Ratio	0.444	0.492
Total Porosity	0.308	0.330
Pore Volume (cc)	63.7	70.5
Degree of Saturation (%) [S meas]	48.6	90.9

SPECIMEN INUNDATION in distilled water for the period of 24 h or expansion rate < 0.0002 in./h.

Date	Time	Pressure (psi)	Elapsed Time (min.)	Dial Readings (in.)
5/14/10	12:02	1.0	0	0.5000
5/14/10	12:12	1.0	10	0.5000
Add Distilled Water to the Specimen				
5/15/10	16:15	1.0	1683	0.5328
5/15/10	17:15	1.0	1743	0.5328

Expansion Index (EI meas) = ((Final Rdg - Initial Rdg) / Initial Thick.) x 1000	32.8
Expansion Index (Report) = Nearest Whole Number or Zero (0) if Initial Height is > than Final Height	33



R-VALUE TEST RESULTS

Project Name: THEODORE PAVEMENT EVAL. / 60 FWY. Date: 5/13/10
 Project Number: 111061-123 Technician: JRH
 Boring Number: B-2 Depth (ft.): 0-5.0
 Sample Number: B-1 Sample Location: **
 Sample Description: SILTY SAND WITH GRAVEL (SM)g, fine to coarse grain, gray. ** Trace AC in sample.

TEST SPECIMEN	A	B	C
MOISTURE AT COMPACTION %	10.5	11.6	12.7
HEIGHT OF SAMPLE, Inches	2.41	2.53	2.45
DRY DENSITY, pcf	123.2	121.8	118.1
COMPACTOR AIR PRESSURE, psi	150	100	50
EXUDATION PRESSURE, psi	368	204	105
EXPANSION, Inches x 10exp-4	50	12	9
STABILITY Ph 2,000 lbs (160 psi)	56	67	78
TURNS DISPLACEMENT	3.32	3.52	3.81
R-VALUE UNCORRECTED	58	50	41
R-VALUE CORRECTED	56	50	41

DESIGN CALCULATION DATA	a	b	c
GRAVEL EQUIVALENT FACTOR	1.0	1.0	1.0
TRAFFIC INDEX	5.0	5.0	5.0
STABILOMETER THICKNESS, ft.	0.70	0.81	0.95
EXPANSION PRESSURE THICKNESS, ft.	1.89	0.45	0.34

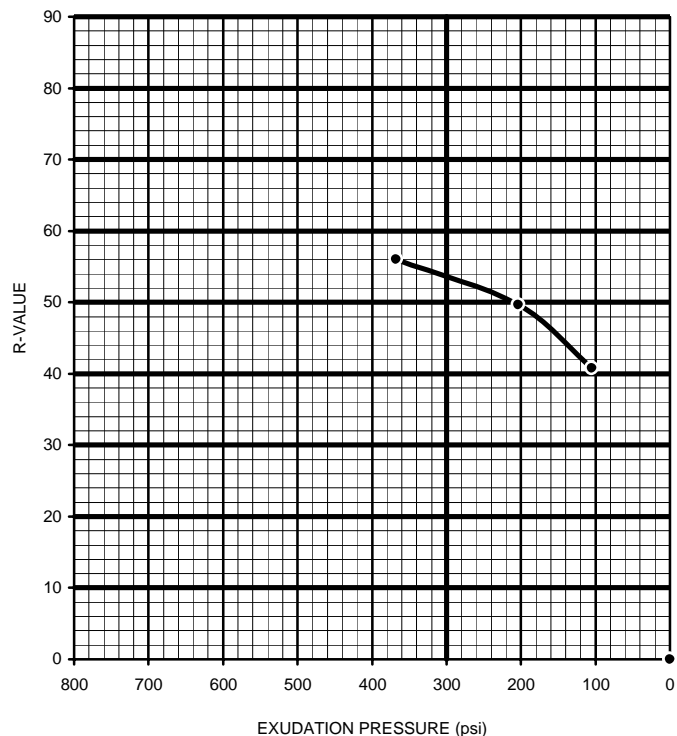
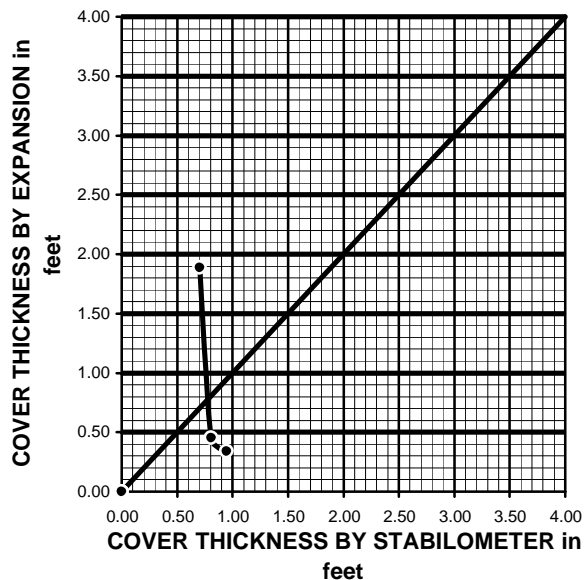

R-VALUE BY EXPANSION: 52
 R-VALUE BY EXUDATION: 54
 EQUILIBRIUM R-VALUE: 52



R-VALUE TEST RESULTS

Project Name: THEODORE PAVEMENT EVAL. / 60 FWY. Date: 5/13/10
 Project Number: 111061-123 Technician: JRH
 Boring Number: C4-C5 Depth (ft.): 1-2.0
 Sample Number: SG-1 Sample Location: **
 Sample Description: SILTY SAND WITH FEW GRAVEL (SM), fine to coarse grain, olive brown.

TEST SPECIMEN	A	B	C
MOISTURE AT COMPACTION %	10.3	11.5	12.6
HEIGHT OF SAMPLE, Inches	2.35	2.45	2.64
DRY DENSITY, pcf	127.0	127.9	119.9
COMPACTOR AIR PRESSURE, psi	150	100	75
EXUDATION PRESSURE, psi	374	207	103
EXPANSION, Inches x 10exp-4	39	25	1
STABILITY Ph 2,000 lbs (160 psi)	53	92	108
TURNS DISPLACEMENT	3.09	3.42	3.71
R-VALUE UNCORRECTED	62	35	24
R-VALUE CORRECTED	58	35	26

DESIGN CALCULATION DATA	a	b	c
GRAVEL EQUIVALENT FACTOR	1.0	1.0	1.0
TRAFFIC INDEX	5.0	5.0	5.0
STABILOMETER THICKNESS, ft.	0.67	1.04	1.18
EXPANSION PRESSURE THICKNESS, ft.	1.47	0.94	0.04

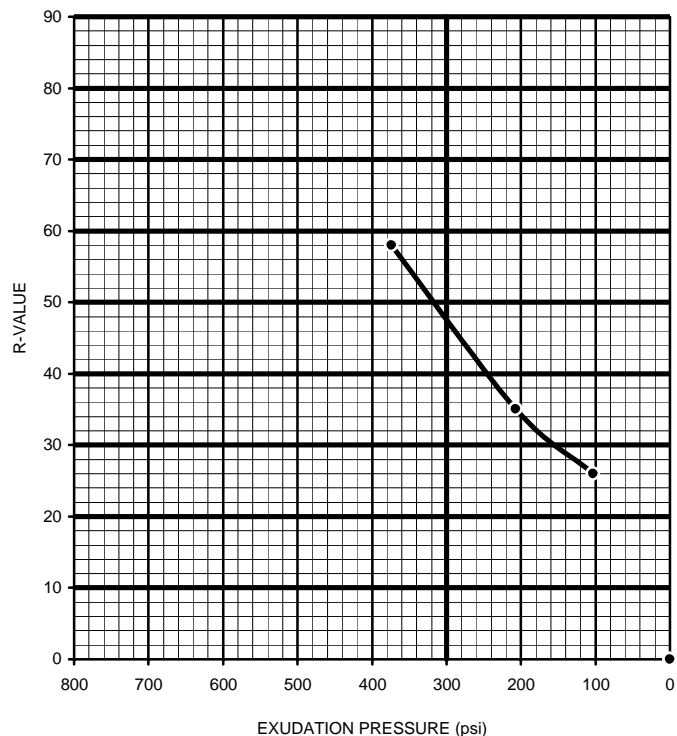
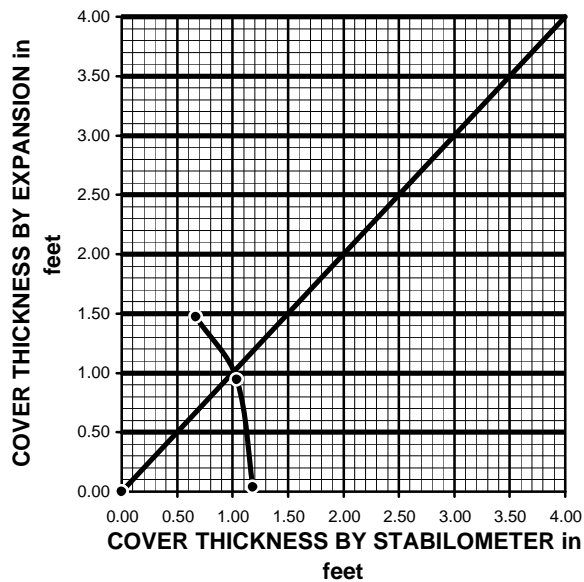

R-VALUE BY EXPANSION: 37
 R-VALUE BY EXUDATION: 48
 EQUILIBRIUM R-VALUE: 37



R-VALUE TEST RESULTS

Project Name: THEODORE PAVEMENT EVAL. / 60 FWY. Date: 5/13/10
 Project Number: 111061-123 Technician: JRH
 Boring Number: C6-C8 Depth (ft.): 1-2.0
 Sample Number: SG-2 Sample Location: **
 Sample Description: SILTY SAND WITH FEW TO LITTLE GRAVEL (SM), fine to coarse grain, brown. ** Trace AC in sample.

TEST SPECIMEN	A	B	C
MOISTURE AT COMPACTION %	8.2	9.3	10.3
HEIGHT OF SAMPLE, Inches	2.41	2.52	2.52
DRY DENSITY, pcf	129.4	129.1	127.8
COMPACTOR AIR PRESSURE, psi	100	75	50
EXUDATION PRESSURE, psi	325	172	103
EXPANSION, Inches x 10exp-4	26	9	0
STABILITY Ph 2,000 lbs (160 psi)	40	71	81
TURNS DISPLACEMENT	3.65	3.76	3.96
R-VALUE UNCORRECTED	67	45	38
R-VALUE CORRECTED	65	45	38

DESIGN CALCULATION DATA	a	b	c
GRAVEL EQUIVALENT FACTOR	1.0	1.0	1.0
TRAFFIC INDEX	5.0	5.0	5.0
STABILOMETER THICKNESS, ft.	0.56	0.87	0.99
EXPANSION PRESSURE THICKNESS, ft.	0.98	0.34	0.00

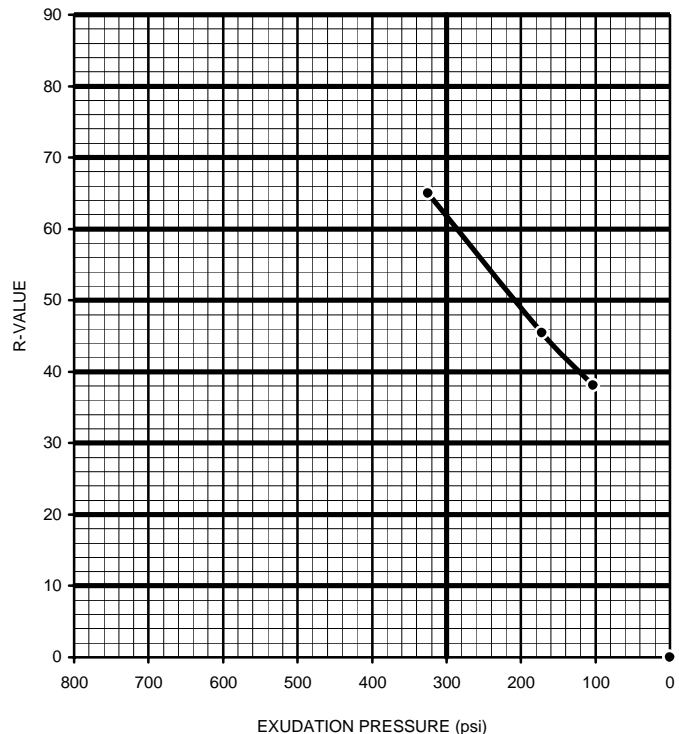
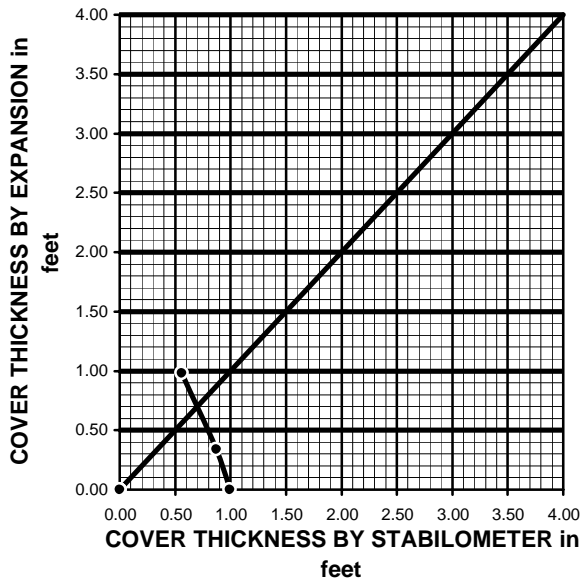

R-VALUE BY EXPANSION: 56
 R-VALUE BY EXUDATION: 62
 EQUILIBRIUM R-VALUE: 56



PARTICLE-SIZE ANALYSIS of SOILS
ASTM D 422

Project Name: THEODORE PAVEMENT EVAL. / 60 FREEWAY Tested By: JRH / JAP Date: 05/17/10

Project No.: 111061-123 Checked By: JMB Date: 05/18/10

Boring No.: B-2 Depth (ft.): 0-5.0

Sample No.: B-1

Visual Sample Description: SILTY SAND WITH GRAVEL (SM)g, fine to coarse grain, gray. ** Trace AC in sample.

		Moisture Content of Total Air - Dry Soil	
Container No.:	EF	Wt. of Air-Dry Soil + Cont. (gm.)	1521.2
Wt. of Air Dry Soil+Cont.(gm.)	1521.2	Wt. of Dry Soil + Cont. (gm.)	1521.2
Wt. of Container (gm.)	214.5	Wt. of Container No. EF (gm.)	214.5
Dry Wt. of Soil (gm.)	1306.7	Moisture Content (%)	0.0

After Wet Sieve	Container No.	EF
	Wt. of Dry Soil + Container (gm.)	949.5
	Wt. of Container (gm.)	214.5
	Dry Wt. of Soil Retained on # 200 Sieve (gm.)	735.0

U. S. Sieve Size		Cumulative Weight Dry Soil Retained (gm.)	Percent Passing %	Spec.
(in.)	(mm.)			
6"	152.400		100.0	**
1"	25.000		100.0	**
3/4"	19.000	0.0	100.0	**
1/2"	12.500	37.4	97.1	**
3/8"	9.500	106.9	91.8	**
#4	4.750	229.5	82.4	**
#8	2.360	319.8	75.5	**
#16	1.180	390.8	70.1	**
#30	0.600	462.2	64.6	**
#50	0.300	541.9	58.5	**
#100	0.150	634.8	51.4	**
#200	0.075	727.8	44.3	**
PAN				

GRAVEL:	18 %	Liquid Limit:	**
SAND:	38 %	Plastic Limit:	**
FINES:	44 %	Plasticity Index:	**
GRP. SYMBOL:	(SM)g	Cu = D60/D10 =	N/A
		Cc = (D30) ² /(D60*D10) =	N/A

Remarks: **

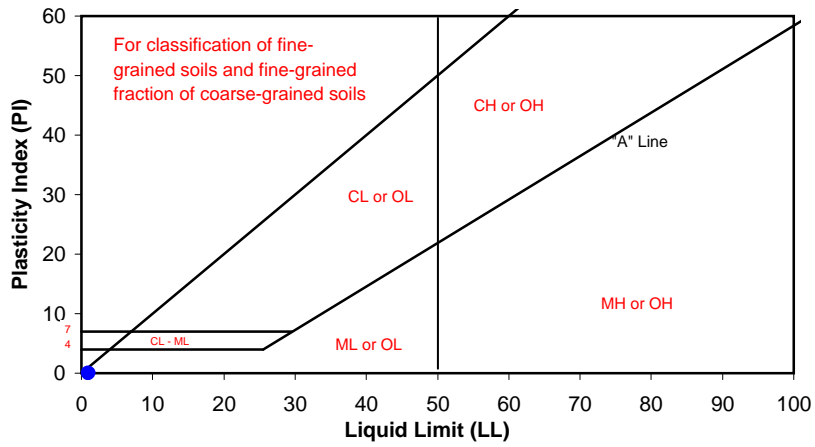

GRAVEL		SAND			FINES
COARSE	FINE	COARSE	MEDIUM	FINE	SILT / CLAY

U.S. STANDARD SIEVE OPENING U.S. STANDARD SIEVE NUMBER
 3.0" 1 1/2" 3/4" 3/8" #4 #8 #16 #30 #50 #100 #200

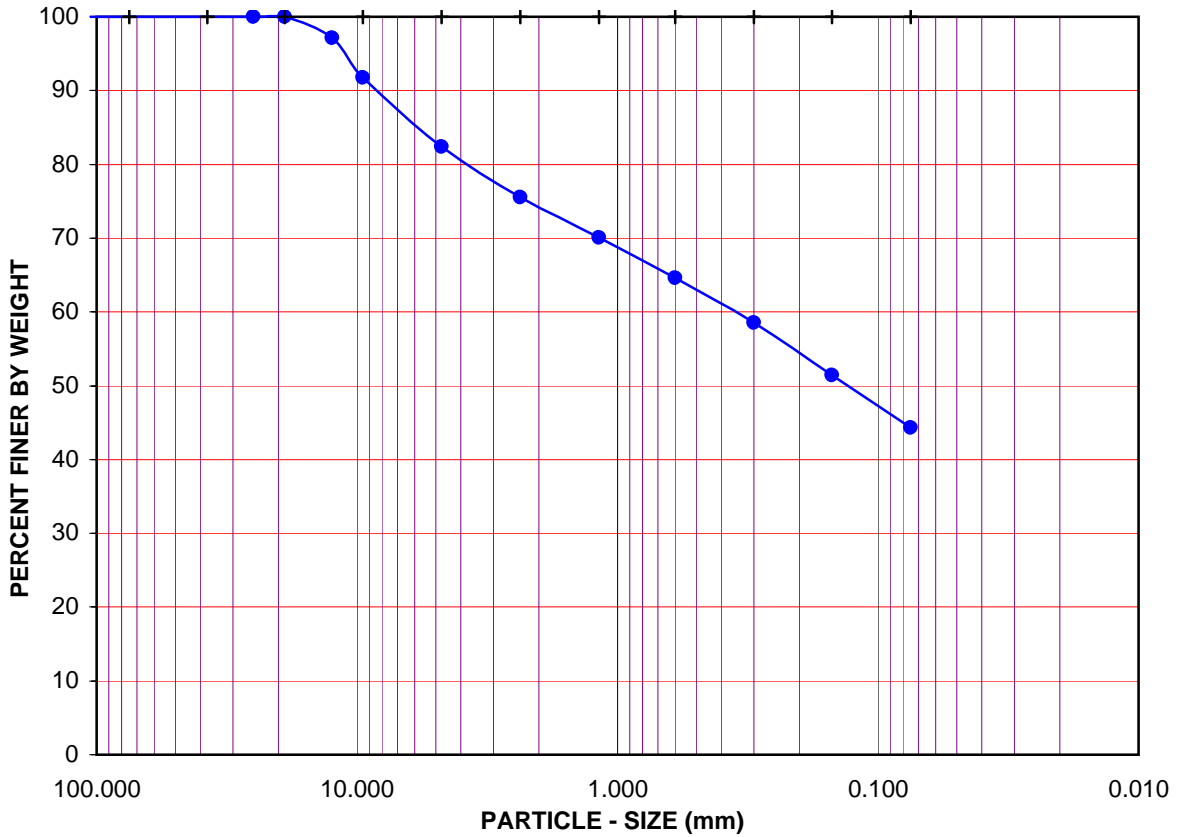

Boring No.:	Sample No.:	Depth (ft.):	Soil Type	GR:SA:FI	LL,PL,PI
B-2	B-1	0-5.0	(SM)g	18 : 38 : 44	** : ** : ** :

Visual Sample Description:
 SILTY SAND WITH GRAVEL (SM)g, fine to coarse grain,
 gray. ** Trace AC in sample.



Project No.: 111061-123
 THEODORE PAVEMENT EVAL. / 60 FREEWAY

PARTICLE - SIZE CURVE
 ASTM D 422



PARTICLE-SIZE ANALYSIS of SOILS
ASTM D-422

Project Name: THEODORE PAVEMENT EVAL. / 60 FWY. Tested By: JRH / JAP Date: 05/17/10
 Project No.: 111061-123 Checked By: JMB Date: 05/18/10
 Boring No.: C2+C3 Depth (ft.): 0.33-0.83
 Sample No.: AB-1
 Visual Sample Description: SILTY SAND WITH GRAVEL (SM)g, fine to coarse grain, pale brown. ** Trace AC in sample.

		Moisture Content of Total Air - Dry Soil	
Container No.:	BL	Wt. of Air-Dry Soil + Cont. (gm.)	2413.4
Wt. of Air Dry Soil+Cont.(gm.)	2413.4	Wt. of Dry Soil + Cont. (gm.)	2413.4
Wt. of Container (gm.)	456.6	Wt. of Container No. BL (gm.)	456.6
Dry Wt. of Soil (gm.)	1956.8	Moisture Content (%)	0.0

After Wet Sieve	Container No.	BL
	Wt. of Dry Soil + Container (gm.)	2065.5
	Wt. of Container (gm.)	456.6
	Dry Wt. of Soil Retained on # 200 Sieve (gm.)	1608.9

U. S. Sieve Size		Cumulative Weight Dry Soil Retained (gm.)	Percent Passing %	Spec.
(in.)	(mm.)			
6"	152.400		100.0	**
1"	25.000	0.0	100.0	**
3/4"	19.000	34.6	98.2	**
1/2"	12.500	227.8	88.4	**
3/8"	9.500	310.0	84.2	**
#4	4.750	542.2	72.3	**
#8	2.360	739.4	62.2	**
#16	1.180	930.1	52.5	**
#30	0.600	1138.2	41.8	**
#50	0.300	1350.8	31.0	**
#100	0.150	1514.7	22.6	**
#200	0.075	1605.0	18.0	**
PAN				

GRAVEL:	28 %	Liquid Limit:	**
SAND:	54 %	Plastic Limit	**
FINES:	18 %	Plasticity Index:	**
GRP. SYMBOL:	(SM)g	Cu = D60/D10 =	N/A
		Cc = (D30) ² /(D60*D10) =	N/A

Remarks: **

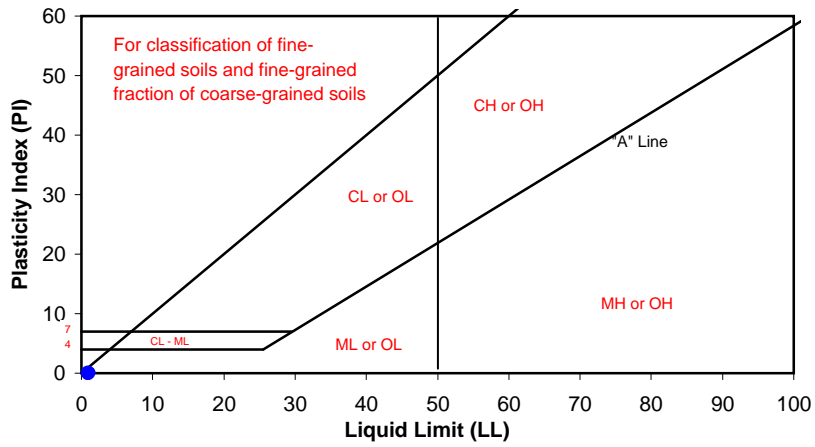

GRAVEL		SAND			FINES
COARSE	FINE	COARSE	MEDIUM	FINE	SILT / CLAY

U.S. STANDARD SIEVE OPENING U.S. STANDARD SIEVE NUMBER

3.0" 1 1/2" 3/4" 3/8" #4 #8 #16 #30 #50 #100 #200

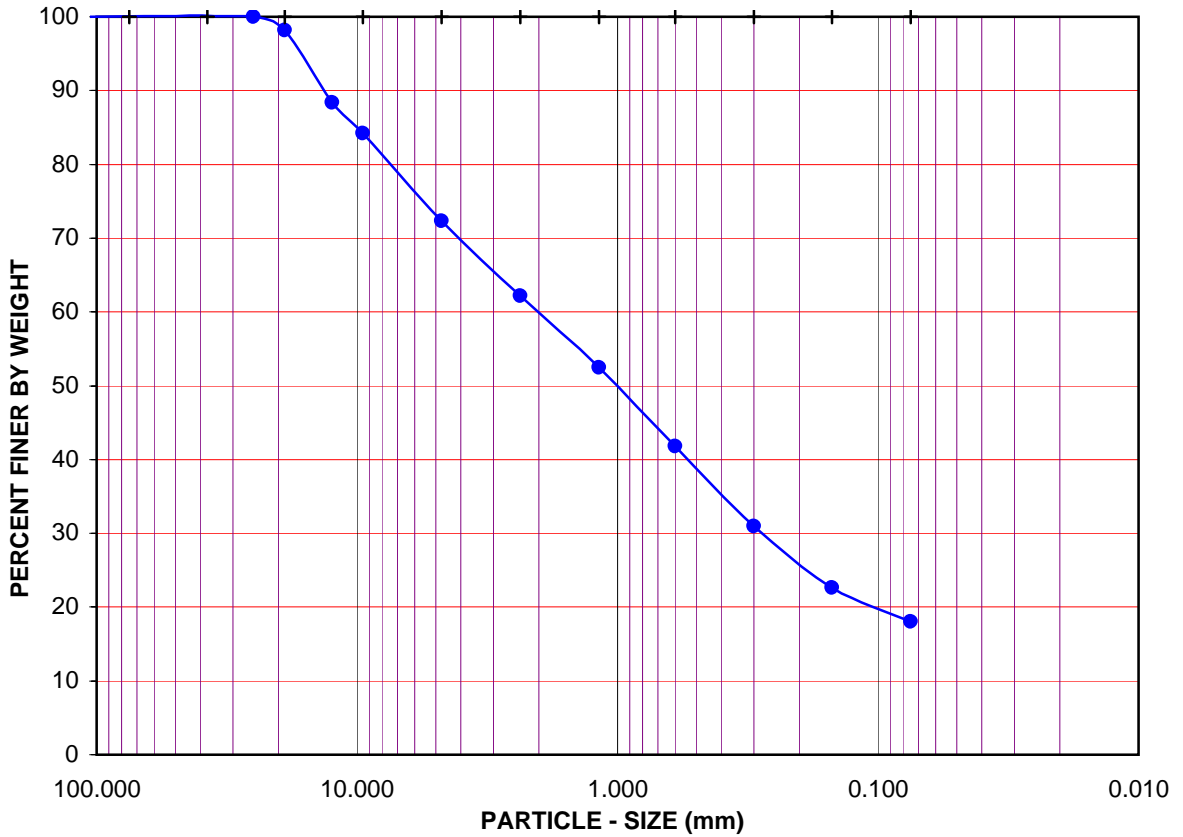

Boring No.:	Sample No.:	Depth (ft.):	Soil Type	GR:SA:FI	LL,PL,PI
C2+C3	AB-1	0.33-0.83	(SM)g	28 : 54 : 18	** : ** : ** :

Visual Sample Description:

SILTY SAND WITH GRAVEL (SM)g, fine to coarse grain, pale brown. ** Trace AC in sample.



Project No.: 111061-123

THEODORE PAVEMENT EVAL. / 60 FWY.

PARTICLE - SIZE CURVE

ASTM D-422



PARTICLE-SIZE ANALYSIS of SOILS
ASTM D-422

Project Name: THEODORE PAVEMENT EVAL. / 60 FWY. Tested By: JRH / JAP Date: 05/17/10
 Project No.: 111061-123 Checked By: JMB Date: 05/18/10
 Boring No.: C6-C8 Depth (ft.): 0.5-1.0
 Sample No.: AB-2
 Visual Sample Description: SILTY SAND WITH GRAVEL (SM)g, fine to coarse grain, pale brown. ** Trace AC in sample.

		Moisture Content of Total Air - Dry Soil	
Container No.:	GH	Wt. of Air-Dry Soil + Cont. (gm.)	1505.8
Wt. of Air Dry Soil+Cont.(gm.)	1505.8	Wt. of Dry Soil + Cont. (gm.)	1505.8
Wt. of Container (gm.)	217.5	Wt. of Container No. GH (gm.)	217.5
Dry Wt. of Soil (gm.)	1288.3	Moisture Content (%)	0.0

After Wet Sieve	Container No.	GH
	Wt. of Dry Soil + Container (gm.)	1183.3
	Wt. of Container (gm.)	217.5
	Dry Wt. of Soil Retained on # 200 Sieve (gm.)	965.8

U. S. Sieve Size		Cumulative Weight Dry Soil Retained (gm.)	Percent Passing %	Spec.
(in.)	(mm.)			
6"	152.400		100.0	**
1"	25.000		100.0	**
3/4"	19.000	0.0	100.0	**
1/2"	12.500	31.8	97.5	**
3/8"	9.500	80.6	93.7	**
#4	4.750	239.8	81.4	**
#8	2.360	383.7	70.2	**
#16	1.180	511.4	60.3	**
#30	0.600	634.8	50.7	**
#50	0.300	762.2	40.8	**
#100	0.150	876.3	32.0	**
#200	0.075	961.1	25.4	**
PAN				

GRAVEL:	19 %	Liquid Limit:	**
SAND:	56 %	Plastic Limit:	**
FINES:	25 %	Plasticity Index:	**
GRP. SYMBOL:	(SM)g	Cu = D60/D10 =	N/A
		Cc = (D30) ² /(D60*D10) =	N/A

Remarks: **

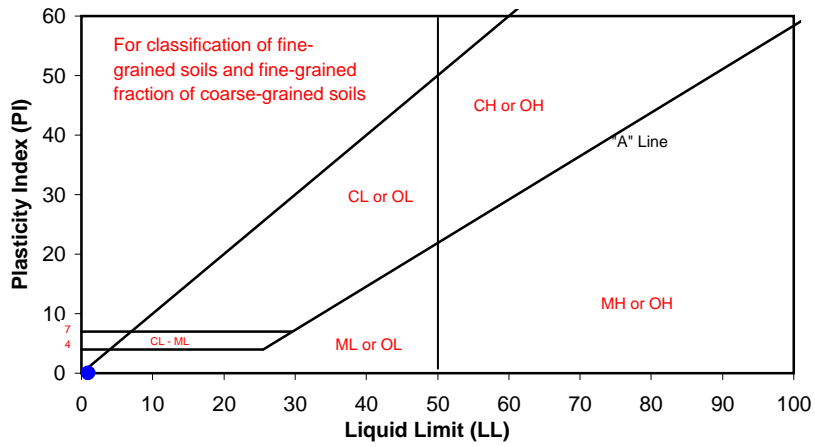

GRAVEL		SAND			FINES
COARSE	FINE	COARSE	MEDIUM	FINE	SILT / CLAY

U.S. STANDARD SIEVE OPENING U.S. STANDARD SIEVE NUMBER
 3.0" 1 1/2" 3/4" 3/8" #4 #8 #16 #30 #50 #100 #200

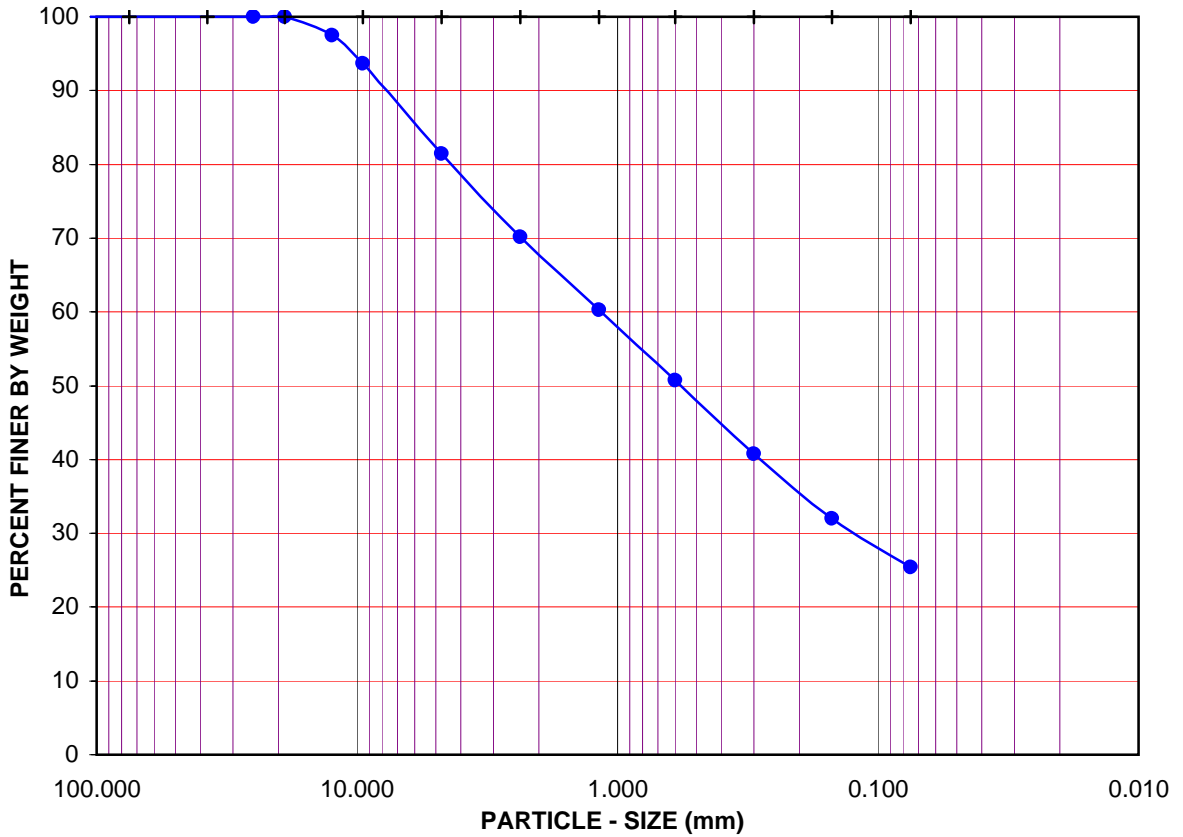

Boring No.:	Sample No.:	Depth (ft.):	Soil Type	GR:SA:FI	LL,PL,PI
C6-C8	AB-2	0.5-1.0	(SM)g	19 : 56 : 25	** : ** : ** :

Visual Sample Description:
 SILTY SAND WITH GRAVEL (SM)g, fine to coarse grain,
 pale brown. ** Trace AC in sample.



Project No.: 111061-123
 THEODORE PAVEMENT EVAL. / 60 FWY.

PARTICLE - SIZE CURVE
 ASTM D-422



TESTS for SULFATE CONTENT CHLORIDE CONTENT and pH of SOILS

Project Name: [THEODORE PAVEMENT EVAL. / 60 FWY.](#) Tested By : [JRH](#) Date: [5/25/10](#)
 Project No. : [111061-123](#) Data Input By: [JMB](#) Date: [5/25/10](#)

Boring No.	B-1				
Sample No.	B-1				
Sample Depth (ft)	0-5.0				
Visual Soil Classification	SM				
Wet Weight of Soil + Container (g)	409.4				
Dry Weight of Soil + Container (g)	409.4				
Weight of Container (g)	0.0				
Moisture Content (%)	0.0				
Weight of Soaked Soil (g)	100.0				

SULFATE CONTENT, Hach Kit Method

Dilution : 1	3				
Water Fraction (ml)	25				
Tube Reading	<50				
PPM Sulfate	<150				
% Sulfate	<0.0150				

CHLORIDE CONTENT, AASHTO T-291

ml of Chloride Soln. For Titration (B)	25				
ml of AgNO3 Soln. Used in Titration (C)	0.6				
PPM of Chloride (C -0.2) * Titre (1) * 1000 / 10g	48				
PPM of Chloride, Dry Wt. Basis	48				

pH TEST, ASTM D-4972

Container No.	X				
Temperature (C°)	21				
pH Value (METHOD A)	7.64				



SOIL RESISTIVITY TEST ASTM G-187

Project Name: <u>THEODORE PAVEMENT EVAL. / 60 FWY.</u>	Tested By : <u>JRH</u>	Date: <u>5/25/10</u>
Project No. : <u>111061-123</u>	Data Input By: <u>JMB</u>	Date: <u>5/25/10</u>
Boring No.: <u>B-1</u>	Checked By: <u>JMB</u>	Date: <u>5/25/10</u>
Sample No. : <u>B-1</u>	Depth (ft.) : <u>0-5.0</u>	
Visual Soil Identification: <u>SM</u>		

** NOTE: ASTM G-187 REQUIRES SOIL SPECIMENS TO PASS THROUGH NO.8 SIEVE PRIOR TO TESTING. THEREFORE, THIS TEST METHOD MAY NOT BE REPRESENTATIVE FOR COARSER MATERIALS.

Initial Moisture Content (%)

Wet Wt. of Soil + Cont. (g)	409.4
Dry Wt. of Soil + Cont. (g)	409.4
Wt. of Container (g)	0.0
Moisture Content (%) (MCi)	0.00

Initial Soil Weight (gm)(Wt)	1500.0
Box Constant:	6.76

$$MC = (((1 + M_{ci}/100) \times (W_a/W_t + 1)) - 1) \times 100$$

Remolded Specimen	Moisture Adjustments				
	Water Added (ml) (W _a)	200	250	300	350
Adj. Moisture Content (%) (MC)	13.33	16.67	20.00	23.33	26.67
Resistance Rdg. (ohm)	4300	2300	1600	460	460
Soil Resistivity (ohm-cm)	29068	15548	10816	3110	3110

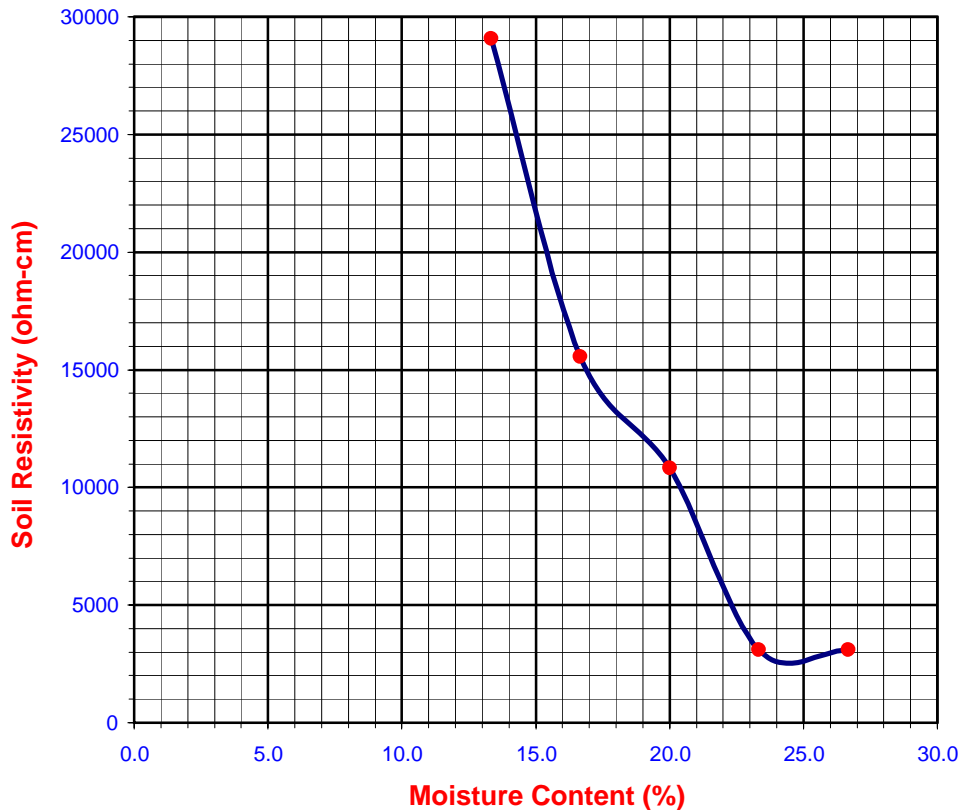

Minimum Resistivity (ohm-cm)	Moisture Content (%)	Sulfate Content ppm / %	Chloride Content (ppm)	Soil pH
ASTM G-187, D-2216		HACH KIT METHOD	AASHTO T-291	ASTM D-4972
3110	23.33	<150 <0.015	48	7.64

APPENDIX B

Planning Study Sheet



DIST	COUNTY	ROUTE	POST MILES TOTAL PROJECT
8	RIV	60	20.0-22.0
CITY OF MORENO VALLEY 14177 FREDERICK ST MORENO VALLEY, CA 92553			
RBF / MICHAEL BAKER INTL. 14725 ALTON PKWY IRVINE, CA 92618			

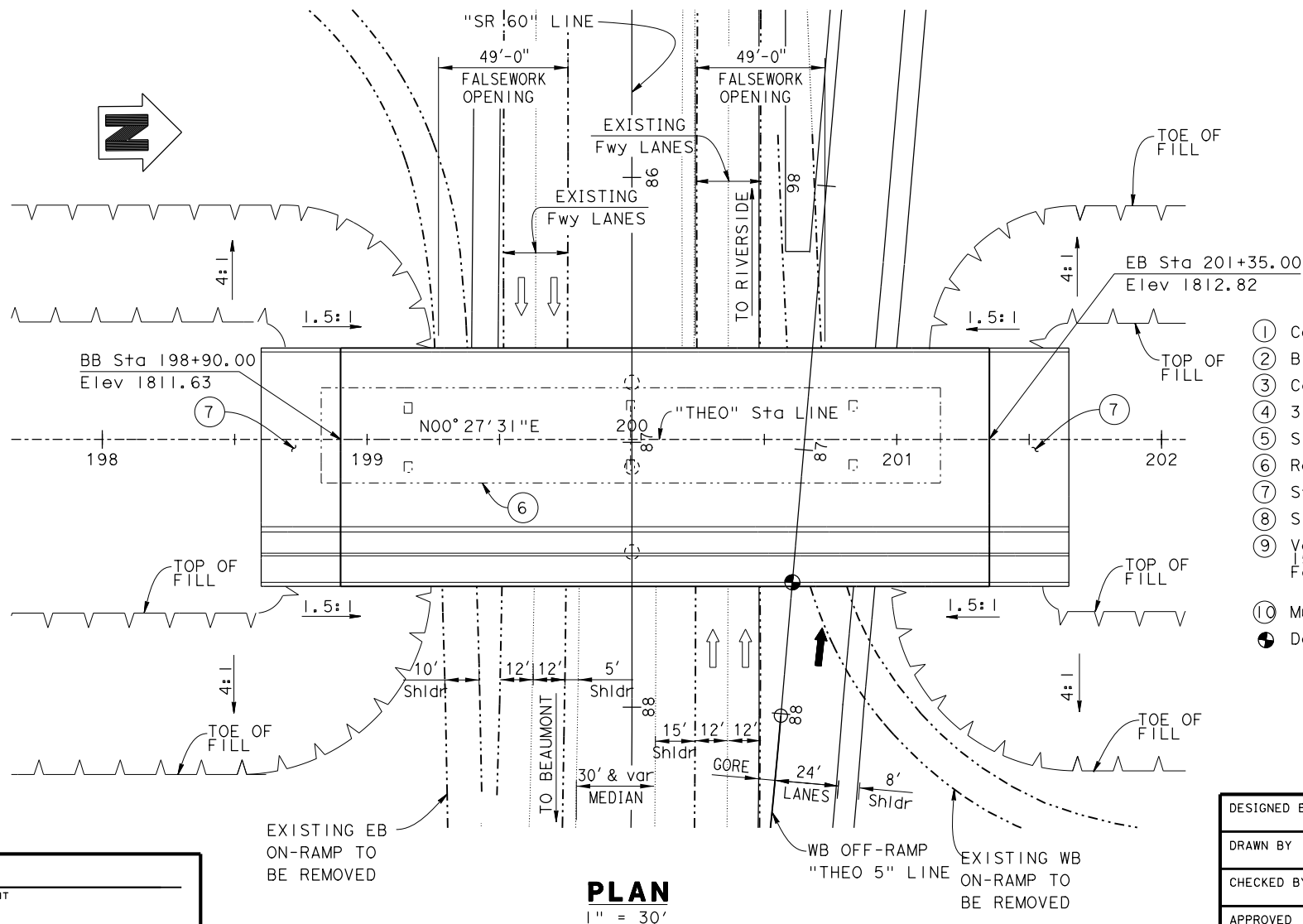
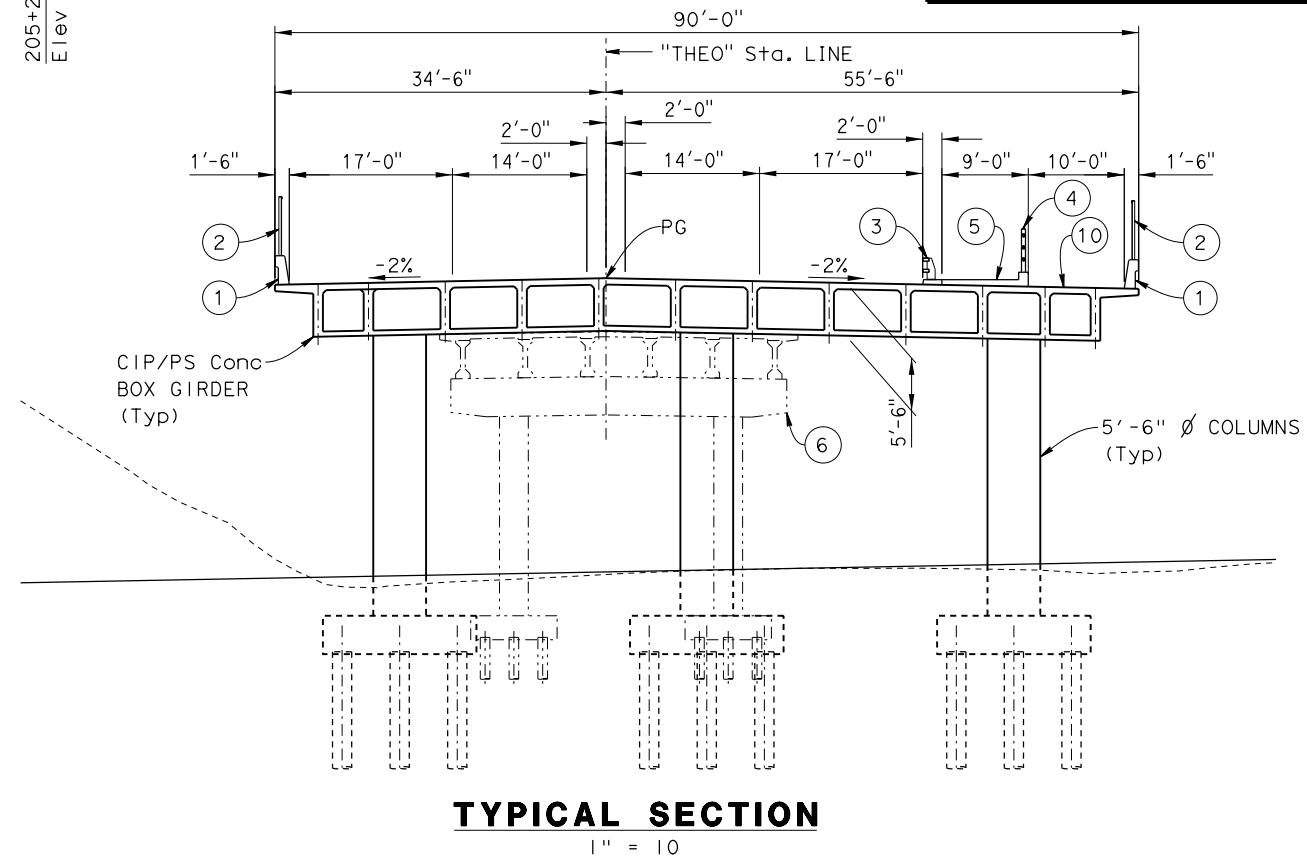
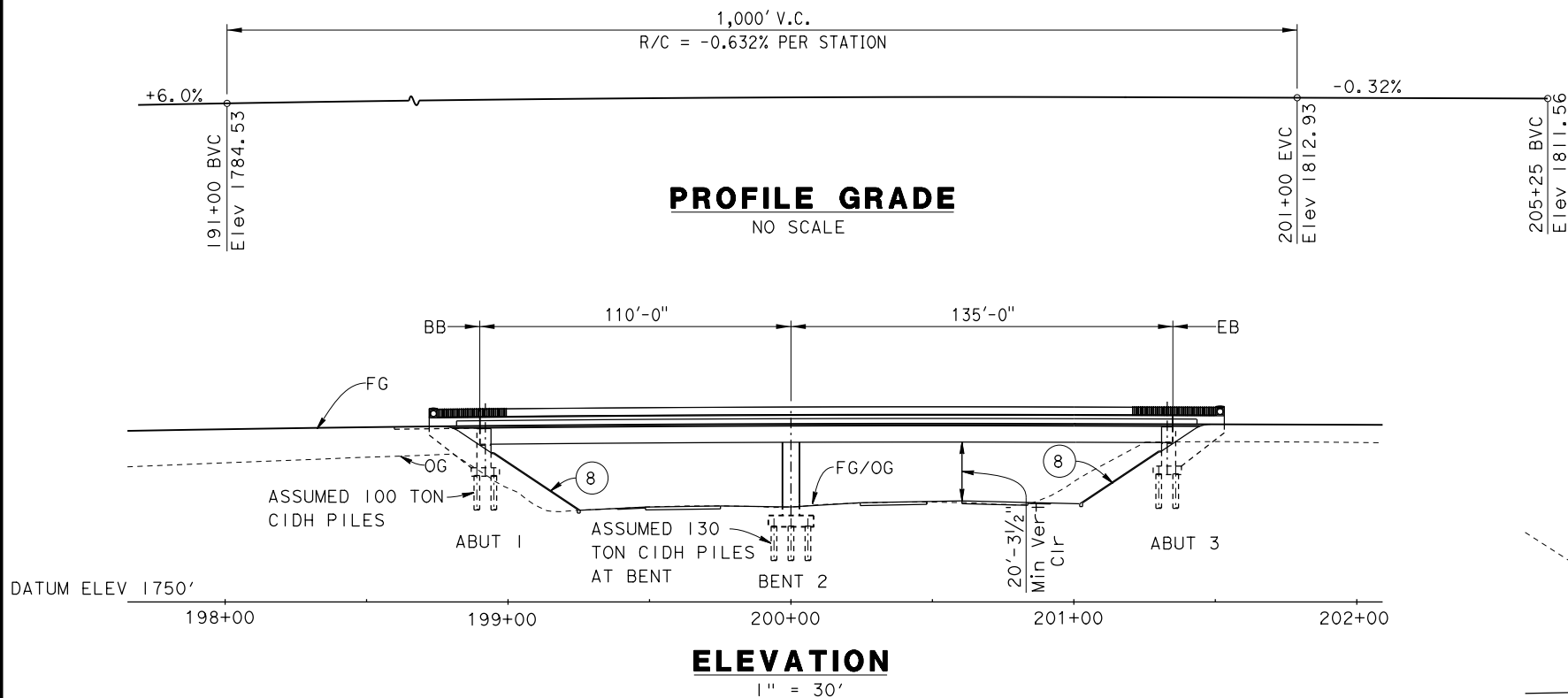

- NOTES:**
- Conc Barrier Type 736 (Mod)
 - Black Picket Steel Fencing
 - California ST-10 Bridge Rail
 - 3' Rail PVC Fence, City of Moreno Valley
 - Sidewalk and Curb
 - Remove Existing Bridge No.56-0488
 - Structure Approach Type N (30S)
 - Slope Paving Full Slope
 - Vehicle Traffic Will Pass Through Construction 15' min Vertical Clearance Required Under Falsework. Falsework to Accommodate 3 Lanes Each Direction
 - Multi Use Trail
 - Denotes Point of Minimum Vertical Clearance

COST DATA

DATE OF ESTIMATE	MAY 2015
BRIDGE REMOVAL	= \$300,000
STRUCTURE DEPTH	= 5'-6"
LENGTH	= 245'-0"
WIDTH	= 90'-0"
AREA	= 22,050 SF
COST/□ INCLUDING 10% MOBILIZATION & 25% CONTINGENCY	= \$288/SF
TOTAL COST NEW BRIDGE	= \$6,350,000

DESIGN OVERSIGHT
SIGN OFF DATE

DESIGNED BY J. MOSQUERA	DATE 4 - 2015
DRAWN BY J. SALDANA	DATE 4 - 2015
CHECKED BY B. MIELKE	DATE 4 - 2015
APPROVED	DATE

J. MOSQUERA
PROJECT ENGINEER

PLANNING STUDY

THEODORE STREET OC ALT 6

BRIDGE NO. 56-TBD	UNIT:
SCALE: AS SHOWN	PROJECT NUMBER & PHASE: 0813000109

DIST	COUNTY	ROUTE	POST MILES TOTAL PROJECT
8	RIV	60	20.0-22.0
CITY OF MORENO VALLEY 14177 FREDERICK ST MORENO VALLEY, CA 92553			
RBF / MICHAEL BAKER INTL. 14725 ALTON PKWY IRVINE, CA 92618			

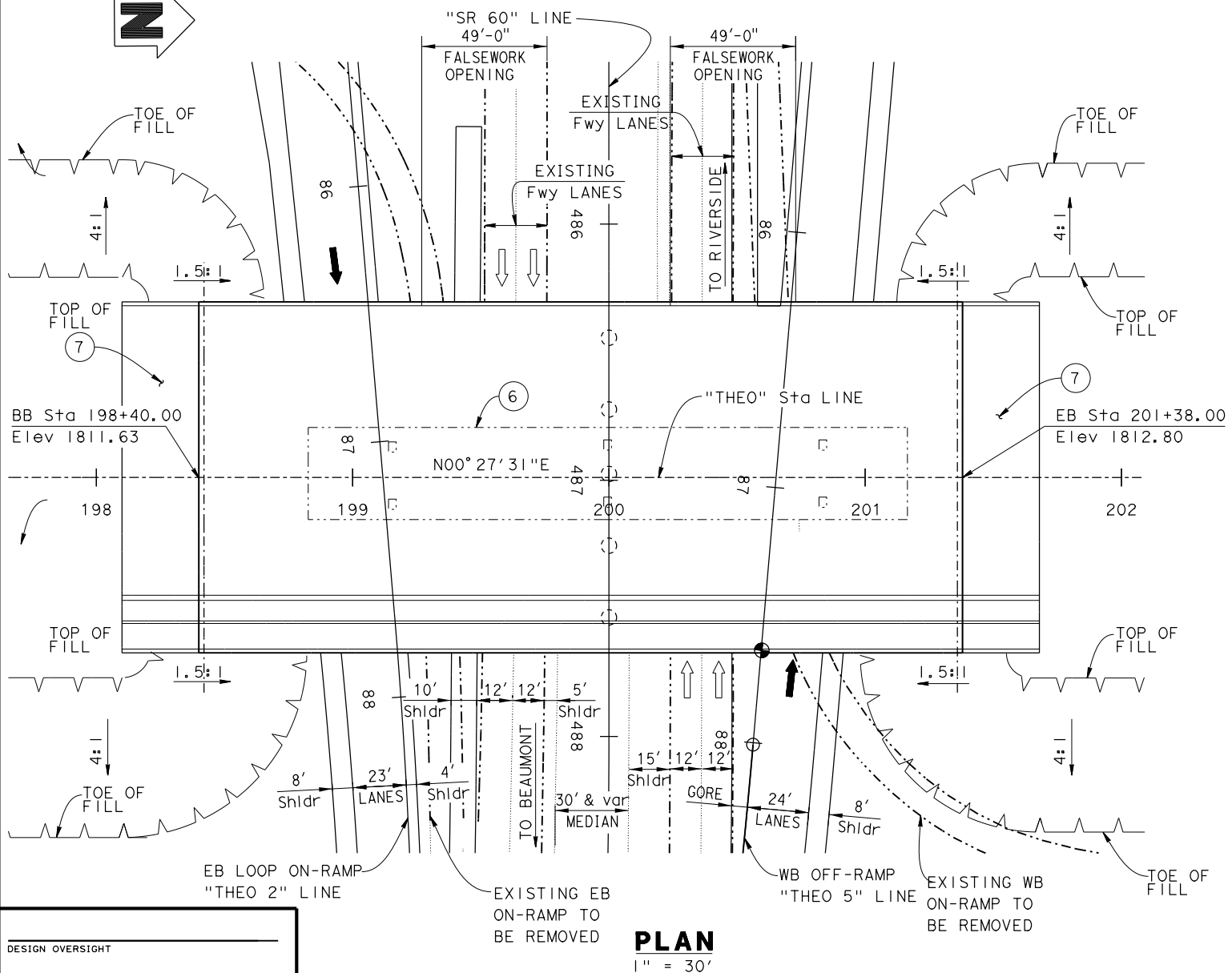
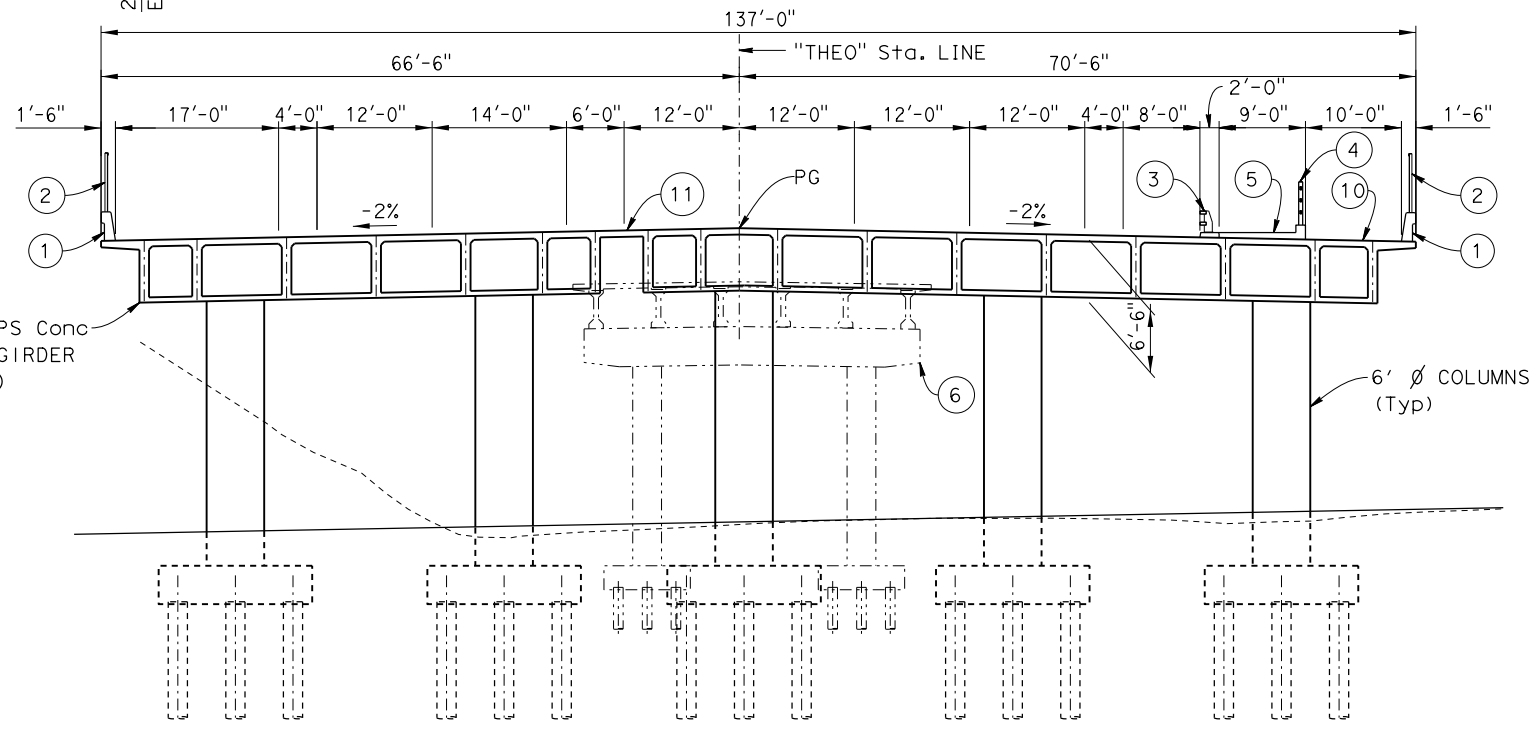
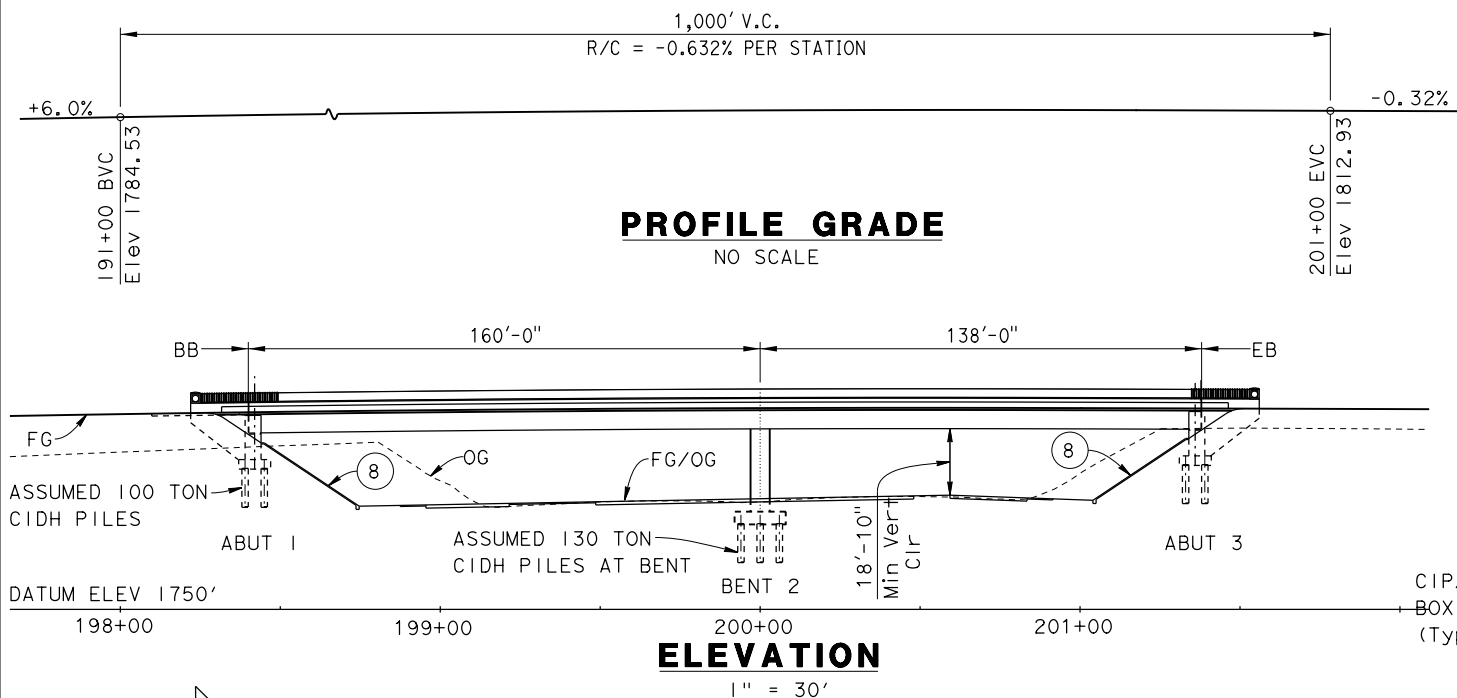

DESIGN OVERSIGHT
SIGN OFF DATE

PLAN
1" = 30'

TYPICAL SECTION
1" = 10'

NOTES:

- ① Conc Barrier Type 736 (Mod)
- ② Black Picket Steel Fencing
- ③ California ST-10 Bridge Rail
- ④ 3' Rail PVC Fence, City of Moreno Valley
- ⑤ Sidewalk and Curb
- ⑥ Remove Existing Bridge No. 56-0488
- ⑦ Structure Approach Type N (30S)
- ⑧ Slope Paving Full Slope
- ⑨ Vehicle Traffic Will Pass Through Construction
15' min Vertical Clearance Required Under Falsework.
Falsework to Accommodate 3 Lanes Each Direction
- ⑩ Multi Use Trail
- ⑪ Closure Pour
- Denotes Point of Minimum Vertical Clearance

COST DATA

DATE OF ESTIMATE	MAY 2015
BRIDGE REMOVAL	= \$300,000
STRUCTURE DEPTH	= 6'-6"
LENGTH	= 298'-0"
WIDTH	= 137'-0"
AREA	= 40,826 SF
COST/□ INCLUDING 10% MOBILIZATION & 25% CONTINGENCY	= \$280/SF
TOTAL COST NEW BRIDGE	= \$11,400,000

DESIGNED BY	J. MOSQUERA	DATE	4 - 2015
DRAWN BY	J. SALDANA	DATE	4 - 2015
CHECKED BY	B. MIELKE	DATE	4 - 2015
APPROVED		DATE	

J. MOSQUERA
PROJECT ENGINEER

PLANNING STUDY	
THEODORE STREET OC ALT 2	
BRIDGE NO. 56-TBD	UNIT:
SCALE: AS SHOWN	PROJECT NUMBER & PHASE: 0813000109